

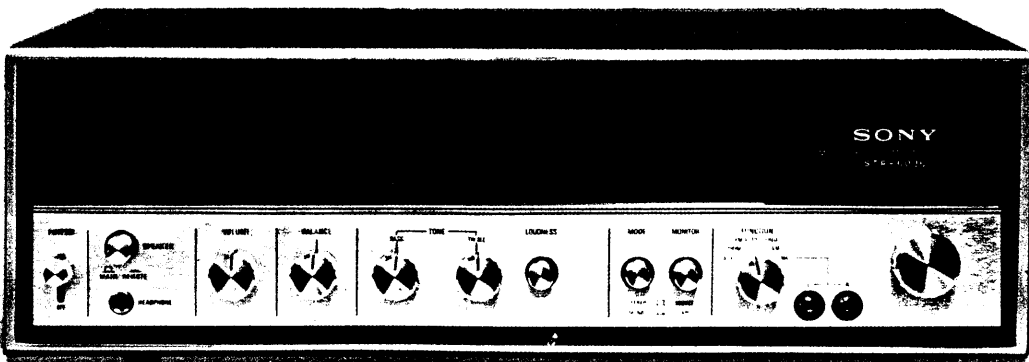

Set using ISO screws

STR-6036

USA and AEP Model



SONY[®]
SERVICE MANUAL

TABLE OF CONTENTS

	<u>Title</u>	<u>Page</u>
SECTION 1. TECHNICAL DESCRIPTION		
1-1.	Technical Specifications	1
1-2.	Circuit Analysis Digest	2~3
1-3.	Block Diagram	4
1-4.	Level Diagram	5
SECTION 2. DISASSEMBLY AND REPLACEMENT PROCEDURES		
2-1.	Tools Required	6
2-2.	Hardware Identification Guide	6
2-3.	Wooden Case Removal	7
2-4.	Front Panel Removal	7
2-5.	Dial-Cord Restrunging	8~9
2-6.	Mechanical Dial Calibration	9
2-7.	Pilot Lamp Replacement	9~10
2-8.	Switch and Control Replacement	10~11
2-9.	Power Transistor Replacement	11
2-10.	Rear Panel Removal	12
2-11.	Replacement of Components Secured to the Rear Panel by Rivets	12
2-12.	Chassis Layout	13
SECTION 3. ALIGNMENT AND ADJUSTMENT PROCEDURES		
3-1.	Fm I-f and Discriminator Alignment	14~16
3-2.	Fm Frequency Coverage and Tracking Alignment	16~17
3-3.	A-m I-f Strip Alignment	18~19
3-4.	A-m Frequency Coverage and Tracking Alignment	19~20
SECTION 4.	REPACKING	22
SECTION 5. DIAGRAMS		
5-1.	Mounting Diagram – Fm (A-m) Front End/I-f Amp/ MPX Board	23
5-2.	Mounting Diagram – Power Amplifier/Power Supply Board –	24
5-3.	Mounting Diagram – Control Board –	25~26
5-4.	Schematic Diagram	27~28
SECTION 6.	EXPLODED VIEW	29~31
SECTION 7.	ELECTRICAL PARTS LIST	32~36

SECTION 1 TECHNICAL DESCRIPTION

1-1. TECHNICAL SPECIFICATIONS

Technical specifications for the STR-6036 are listed in Table 1-1.

**TABLE 1-1.
STR-6036 TECHNICAL SPECIFICATIONS**

Fm-Tuner Section	
Frequency range:	87.5 to 108 MHz
Intermediate frequency:	10.7 MHz
Usable sensitivity:	2.0 μ V (S/N = 30 dB) 1.4 μ V (S/N = 20 dB)
Signal-to-noise ratio:	65 dB, IHF
Capture ratio:	1.6 dB, IHF
Selectivity:	55 dB, IHF
Image rejection:	50 dB
I-f rejection:	82 dB
Spurious signal rejection:	78 dB
A-m suppression:	50 dB
Frequency response:	30 to 15,000 Hz \pm 0 dB
Antenna:	300 ohms balanced
Harmonic distortion:	Mono: 0.3% at 400 Hz Stereo: 0.8% at 400 Hz
Fm-stereo separation:	Greater than 35 dB at 400 Hz
19-kHz, 38-kHz suppression:	50 dB
A-m Tuner Section	
Frequency range:	530 to 1,605 kHz
Intermediate frequency:	455 kHz
Sensitivity:	48 dB/m, built-in ant. 30 μ V, external ant.
Signal-to-noise ratio:	50 dB
Image rejection:	56 dB at 1,000 kHz
I-f rejection:	40 dB at 1,000 kHz
Harmonic distortion:	0.8%

Audio-Amplifier Section

Dynamic power output (IHF):	44 watts, both channels operating, 8 ohms, 0.5% THD
Rated output: (1 kHz)	14 watts, per channel, both channels operating, 8 ohms
Rated output: (40 Hz ~ 12.5 kHz)	12 watts, per channel, both channels operating, 8 ohms
Power band width:	40 Hz ~ 20 kHz (IHF)
Harmonic distortion:	Less than 0.8% at 1 kHz at rated output Less than 0.1% at 1 watt output
Frequency response:	TAPE } AUX } 30 to 40 kHz (\pm 3 dB) MIC }
Input sensitivity and impedance:	PHONO: 2.5 mV, 47k ohms TAPE: 250 mV, 100k ohms AUX: 250 mV, 100k ohms MIC: 2 mV, 47k ohms REC/PB: 250 mV, 100k ohms
Signal output:	REC OUT: 250 mV, 10 k ohms REC/PB: 30 mV, 82 k ohms
Signal-to-noise ratio:	PHONO: greater than 60 dB MIC: greater than 60 dB AUX: greater than 70 dB TAPE: greater than 80 dB REC/PB: greater than 80 dB
Tone controls:	BASS: \pm 10 dB at 100 Hz TREBLE: \pm 10 dB at 10 kHz
Loudness:	6 dB up at 50 Hz 4 dB up at 10 kHz (VOLUME-control attenuation: 30 dB)
Residual noise:	Less than 0.08 μ watts
General	
Power consumption:	100 watts
Power requirements:	120V 60Hz, ac (USA Model) 100, 120, 220, 240V 50/60 Hz, ac (AEP Model)
Dimensions:	17 $\frac{1}{8}$ " (width) \times 5 $\frac{11}{16}$ " (height) \times 13 $\frac{3}{16}$ " (depth) 434 mm (width) \times 144 mm (height) \times 345 mm (depth)
Net weight:	18lb 11 oz (8.5 kg)
Shipping weight:	25lb 7 oz (11.5 kg)

1-2. CIRCUIT ANALYSIS DIGEST

The following describes the functions of newly adapted circuit or complicated circuit which might help your repair work.

Since stages are listed by transistor reference designation, refer to the schematic diagram on page 27 to 28.

Fm Mixer: Q102

Rf signals and local-oscillator voltage are heterodyned in the base-emitter junction of mixer to produce 10.7 MHz i-f output signal. Transformer IFT101, C105 and C106 form a high "C" pi-network bandpass filter, which passes the i-f output and provides a path to ground for the other heterodyne products and oscillator harmonics.

Fm I-f Amplifiers: Q201 to Q205

The i-f amplifier stages consist of two pairs of direct-coupled amplifiers that provide essentially flat response. The selectivity of this section is determined by two-pairs of filters (CF201, CF202, CF203 and CF204) in the inter-stage-coupling path.

STEREO Lamp Circuit: Q304, Q305

The STEREO lamp lights when an fm-stereo signal is received. The emitter of Q305 is connected to the base of Q304, which is normally cut off.

When a composite stereo signal is applied to the multiplex decoder, the 38-kHz pulses produced at the output of the frequency doubler yield a higher-average current flow through Q305. This forces Q304 into conduction, lighting STEREO lamp PL905.

Multiplex Demodulator: L302, D303, D304, D305 and D306

L302 (switching transformer) and four diodes form a balanced bridge arrangement. This system has the advantage of cancelling residual rf components (38-kHz signal, some 19-kHz signal, and higher-order harmonics of these frequencies). Notice that the 38-kHz switching signal is transformer-coupled to the diode bridge to supply while a composite stereo signal is applied to the sampling drive for the demodulator center tap of the secondary winding of L302.

"L" and "R" components are developed at each side of the bridge as the result of demodulation, see Fig. 1-1.

In the monaural mode, diodes D303 and D304 are forward biased by supply voltage through R324, STEREO lamp, R321, R326 and R327 so these diodes merely act as small resistances. Under this condition, the monaural signal is applied to both "L" and "R" audio amplifiers.

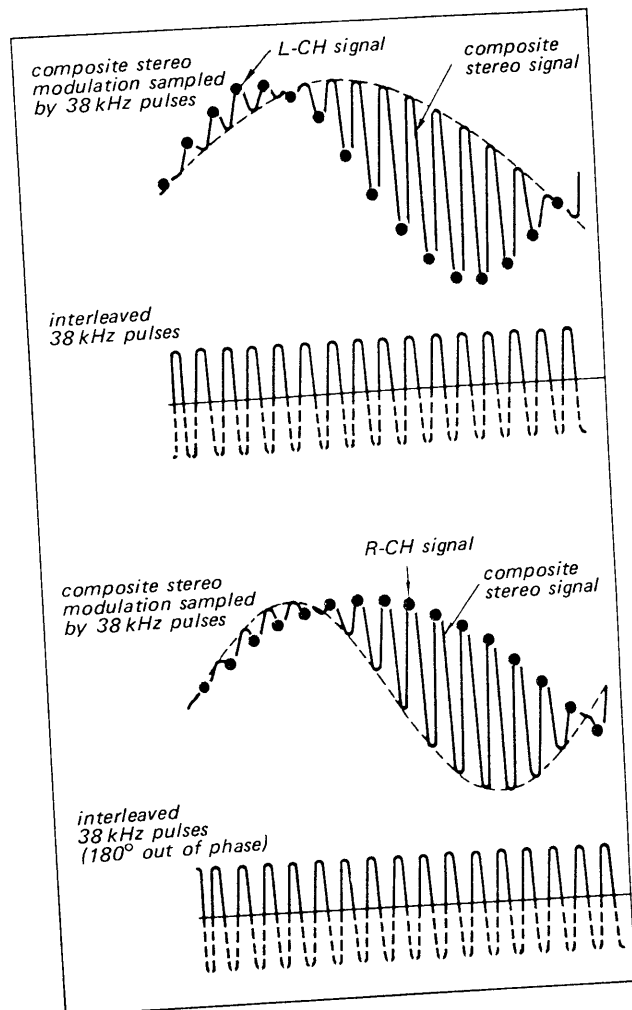

Fig. 1-1. Stereo demodulation operation

A-m AGC: D402, Q403, Q401

There are two feedback loops ensuring proper agc operation. (See Fig. 1-2.) The a-m i-f signal is detected by D402 at the secondary winding of IFT402.

The output of the diode D402 is a positive dc voltage roughly proportional (not exactly due to agc action) to the carrier levels of input signal. This is fed to the base of Q403 through filter circuit consist of C426, R428 and C425, controlling bias current of Q403 thereby its emitter voltage.

Emitter voltage of Q403 is fed back to the base circuit of Q401 (mixer) through filter circuit R427, C422 and C421. Q401 acts as forward agc element by utilizing the relationship between transistor's current gain (hfe) and collector-emitter voltage (Vce) as illustrated in Fig. 1-3. Agc operates as follows:

When strong signal is received, current flow in Q401 and Q403 increases due to agc circuit.

Since relatively large resistor is inserted in the collector circuit of Q401, higher current flow causes decrease of collector-emitter voltage (V_{ce}) thereby reducing its gain to maintain stable operation.

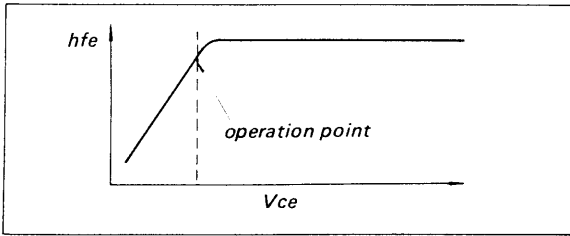

Fig. 1-3. h_{fe} - V_{ce} relationship

Audio Section

Tone Control Circuit: Q504

Fig. 1-4 shows a partial schematic diagram of tone control circuit. This circuit is a modified negative-feedback type tone-control. Note that the output generated at the collector circuit of Q504 is fed back to the base circuit of Q504 through the treble and bass control circuit.

Separation Adjustment Circuit: Q501, Q551, RT501

The network that connects the emitters of Q501 and Q551 provides a form of negative feedback between left and right channels for fm stereo signals.

Any residual "R" signal in the "L" channel (which is about 180° out of phase) is cancelled out by the "R" channel. The same is true of residual "L" signal in the "R" channel. RT501 is therefore set for maximum separation.

Dc Bias Power Supply: Q603 (power amplifier)

Q603 is forced to conduct and operates as a small resistance providing the necessary forward bias on the two cascaded emitter-followers (complementary and power amplifier stages). R609 and R608 determines the impedance between the emitter and collector of Q603, and thereby determines the dc bias voltage for the following complementary circuit.

This circuit has the advantage of compensating a lack of idling current at high output power.

Power Amplifier: Q606, Q607, D601, D602

The output transistors Q606 and Q607 are cascaded supplying power to the speaker system.

Q606 supplies power to the load during the positive half cycle and Q607 operates during the negative half cycle. Output is coupled to the speakers through C608.

Notice that diodes D601 and D602 are paralleled across resistors, R616 and R617 to increase the output power which is restricted by R616 and R617 without reducing stability of power amplifier.

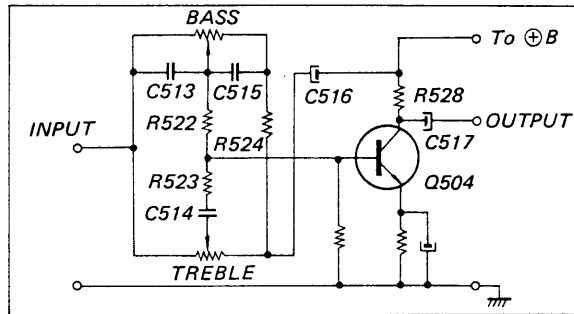

Fig. 1-4. Tone control circuit

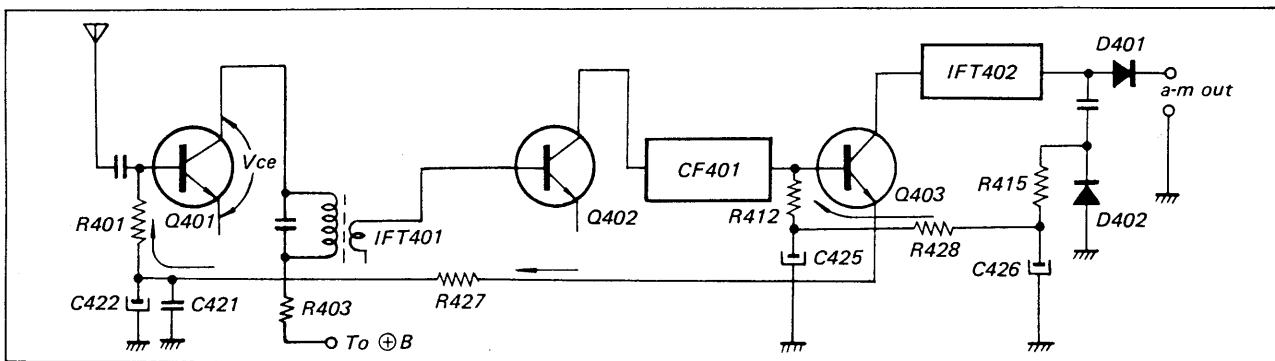
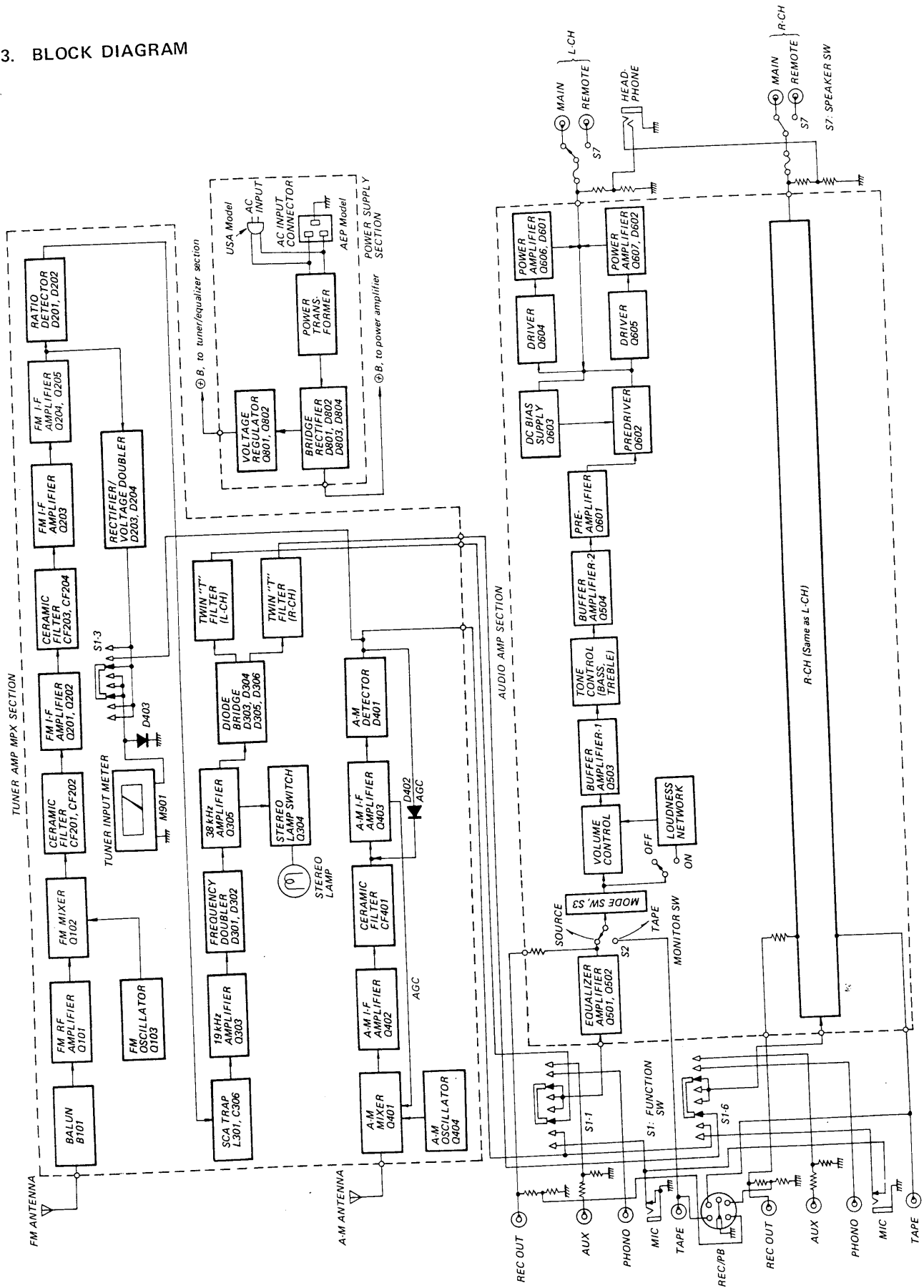
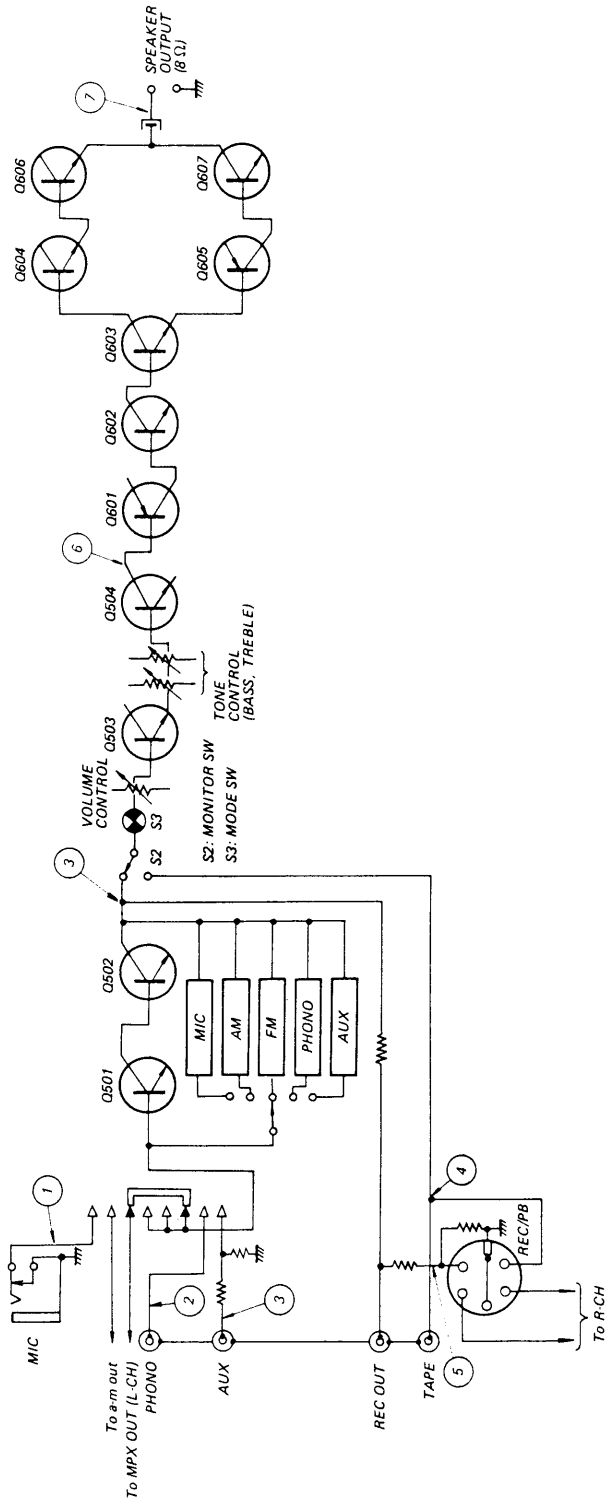
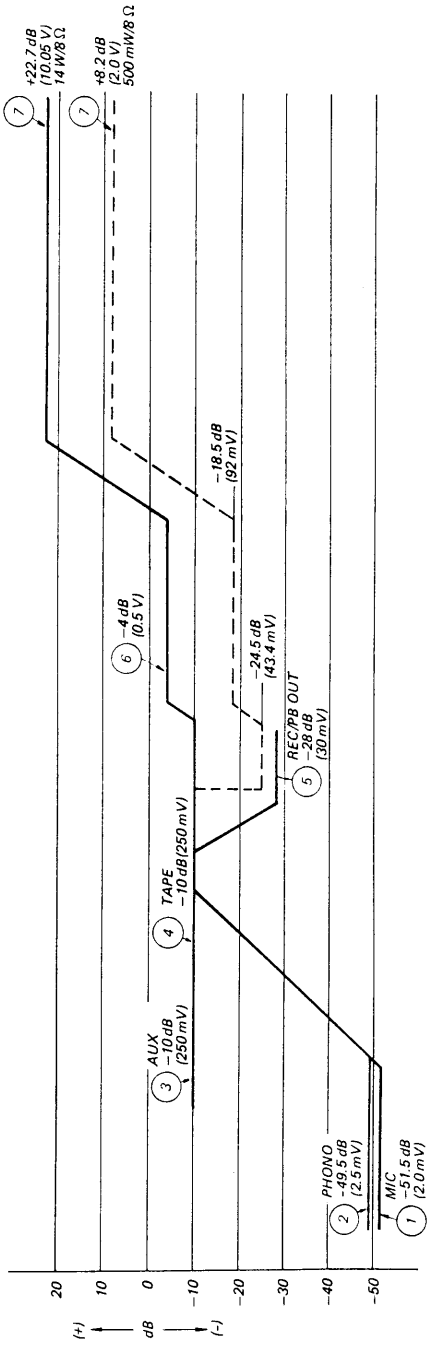

Fig. 1-2. Simplified agc circuit

1-3. BLOCK DIAGRAM



14. LEVEL DIAGRAM



SECTION 2 DISASSEMBLY AND REPLACEMENT PROCEDURES

WARNING

Unplug the ac power cord before starting any disassembly or replacement procedures.

2-1. TOOLS REQUIRED

The following tools are required to perform disassembly and replacement procedures on the STR-6036.

- Screwdriver, Phillips-head
- Screwdriver, 4-inch cabinet
- Wrench, 6-inch adjustable
- Cardboard, 3-inch-square
- Protective pad
- Cellophane tape
- Soldering iron, 40 to 150 watts
- Cement, contact
- Cement solvent
- Diagonal cutters
- Pliers, long-nose
- Soldering tool, wire-brush end
- Tweezers, 6-inch
- Tape, electrical
- Silicone grease
- Nutdriver, 3-mm
- Solder, rosin-core
- Electric drill
- Drill bits
- Prick punch

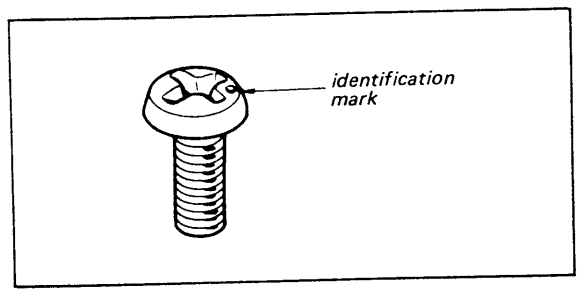

Fig. 2-1. ISO screw

2-2. HARDWARE IDENTIFICATION GUIDE

The following chart will help you to decipher the hardware codes given in this service manual.

Note: All screws in the STR-6036 are manufactured to the specifications of International Organization for Standardization (ISO). This means that the new and old screws are not interchangeable because ISO screws have a different number of threads per mm compared to the old ones. The ISO screws have an identification mark on their heads as shown in Fig. 2-1.

— Hardware Nomenclature —

P	— Pan Head Screw		
PS	— Pan Head Screw with Spring Washer		
K	— Flat Countersunk Head Screw		
B	— Binding Head Screw		
RK	— Oval Countersunk Head Screw		
T	— Truss Head Screw		
R	— Round Head Screw		
F	— Flat Fillister Head Screw		
SC	— Set Screw		
E	— Retaining Ring (E Washer)		
	W — Washer		
	SW — Spring Washer		
	LW — Lock Washer		
	N — Nut		

— Example —

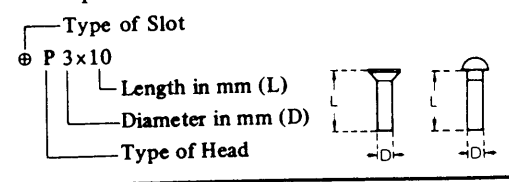

2-3. WOODEN CASE REMOVAL

1. Remove the six screws at the bottom of the wooden case as shown in Fig. 2-2.

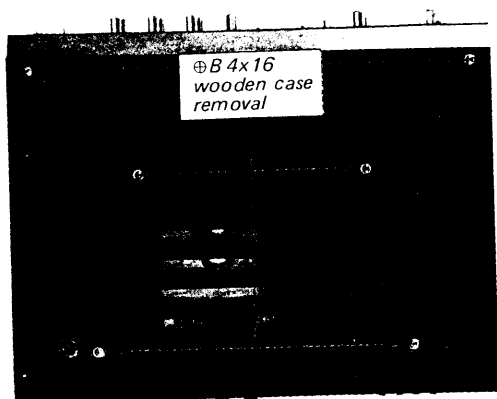

Fig. 2-2. Wooden case removal

2-4. FRONT PANEL REMOVAL

1. Remove the wooden case as described in Procedure 2-3.
2. Remove all the control knobs, except tuning knob by pulling them off.
3. Remove the tuning knob by loosening the two set screws.

4. Remove the three hex nuts securing FUNCTION switch and VOLUME, TREBLE control to the control panel.
Place a piece of cardboard between the wrench and control panel to avoid marring the panel. See Fig. 2-3. This frees the control panel.
5. Remove the four screws securing the front panel to the front subchassis as shown in Fig. 2-4. This frees the front panel.

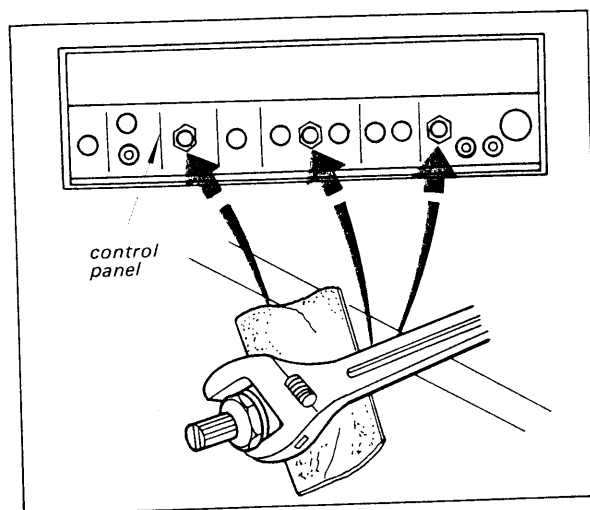

Fig. 2-3. Hex nut removal

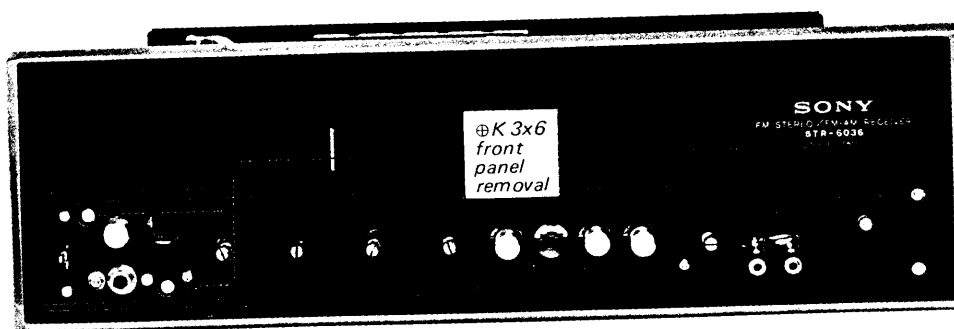

Fig. 2-4. Front panel removal

For Service Manuals
MAURITRON SERVICES
 8 Cherry Tree Road, Chinnor
 Oxfordshire, OX9 4QY.
 Tel (01844) 351694
 Fax (01844) 352554
 email:- sales@mauritron.co.uk

2.5. DIAL CORD RESTRINGING

Preparation

1. Remove the wooden case as described in Procedure 2-3.
2. Cut a 70-inch (1,700 mm) length of $\frac{1}{64}$ -inch (0.3 mm) diameter dial cord.
3. Tie the end of the cord to a spring as shown in Fig. 2-5.
4. Rotate the tuning-capacitor drive drum fully counterclockwise (minimum capacitance position).

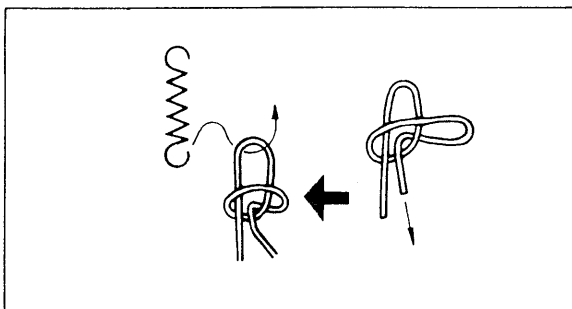

Fig. 2-5. Tying square knot in the coil spring

Procedure

While referring to Fig. 2-6, proceed as follows:

1. Hook the spring to one hole of the drive drum, and then squeeze it as shown in Fig. 2-7.
2. Run the cord through the slot in the rim of the drum and wrap a clockwise turn in the inner side groove. See Fig. 2-8.
3. Run the cord over pulley "A", and then wrap two clockwise turns around the tuning shaft.
4. Run the cord over pulleys "B", "C" and "D" then wrap one clockwise turn around the drum from outer groove to inner groove as shown in Fig. 2-8.
5. Pass the doubled end of the cord through the eyelet (See Fig. 2-9), then hook it to the spring as shown in Fig. 2-10.
6. Tighten the cord, then squeeze the eyelet so that the spring is under tension. Make a knot in the cord end to keep it from slipping out of the eyelet. See Fig. 2-9.
7. After completing the dial cord stringing, make sure that the tuning system works properly. Apply a drop of contact cement to the finish point, and then follow the mechanical dial calibration.

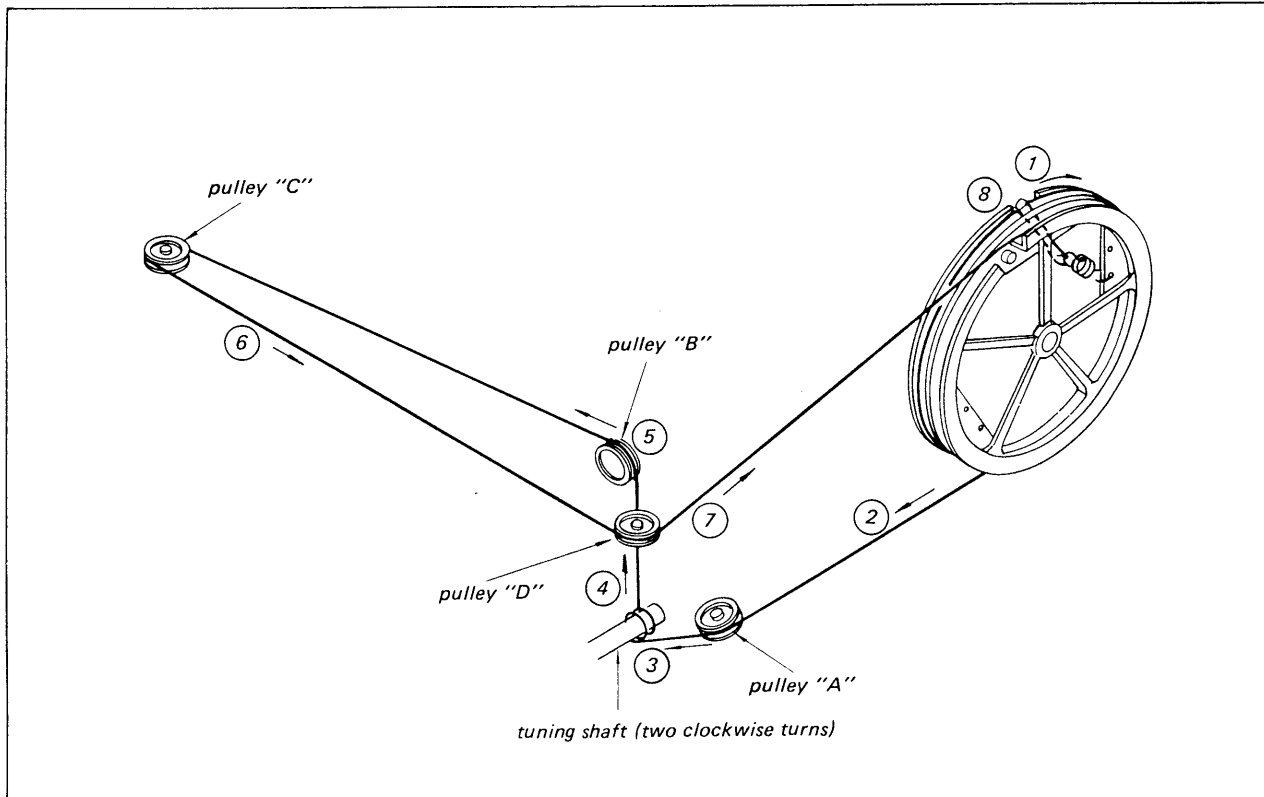

Fig. 2-6. Dial cord stringing

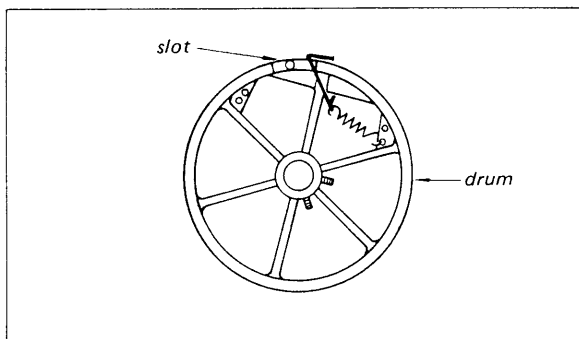

Fig. 2-7. Coil spring installation

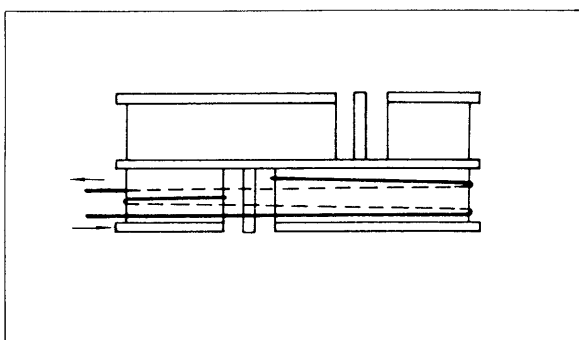

Fig. 2-8. Wrapping the dial cord

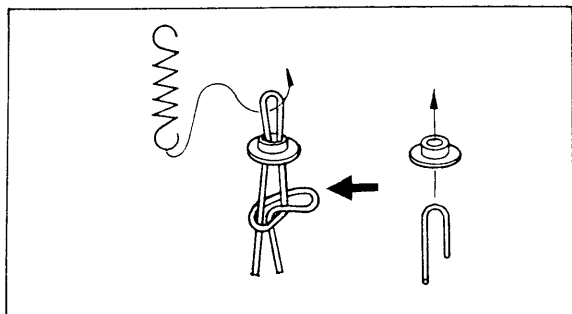

Fig. 2-9. Detail of dial cord finish

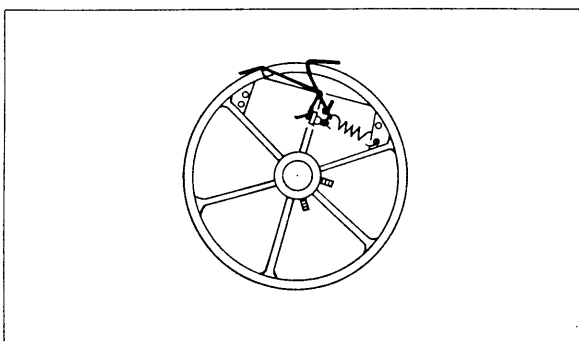

Fig. 2-10. End of dial cord stringing

2-6. MECHANICAL DIAL CALIBRATION

Note: This is a temporary dial pointer calibration, thereby the dial pointer should be fixed firmly after completing frequency coverage adjustment as described in Procedure 3-2.

1. Put the dial pointer on the cord as shown in Fig. 2-11 and move it to a position where the pointer comes to 5 mm right from the left edge of the dial scale as shown in Fig. 2-12.

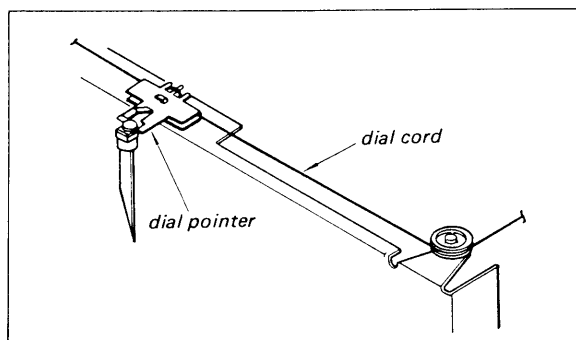

Fig. 2-11. Dial pointer installation

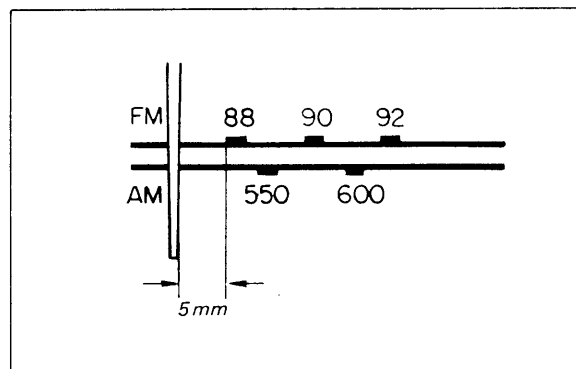

Fig. 2-12. Mechanical dial calibration

2-7. PILOT LAMP REPLACEMENT

Stereo Lamp

1. Pull the lamp from its rubber holder.
2. Unsolder the defective lamp lead from the connecting terminals on the tuner and MPX board, and then install the new lamp.

Dial Lamp

1. Remove the one self-tapping screw as illustrated in Fig. 2-13, and then install the replacement lamp.

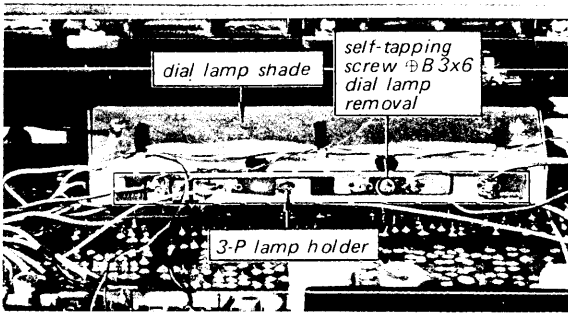

Fig. 2-13. Dial lamp replacement

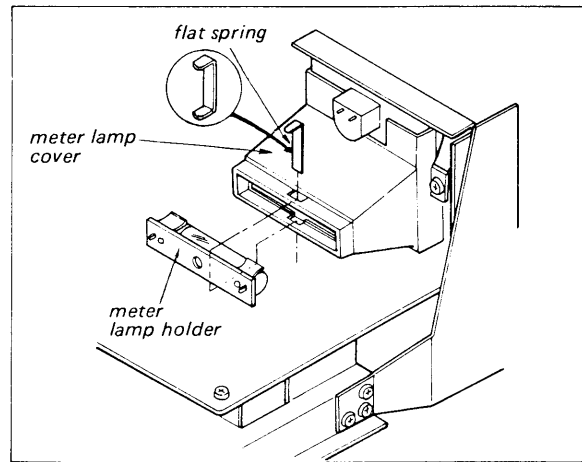

Fig. 2-14. Meter lamp replacement

Meter Lamp

1. Remove the flat spring as illustrated in Fig. 2-14, and then install the replacement lamp.

2-8. SWITCH AND CONTROL REPLACEMENT

Preparation

1. Remove the front panel as described in Procedure 2-4.
2. Fasten the dial cord to the drum or pulleys with cellophane tape.

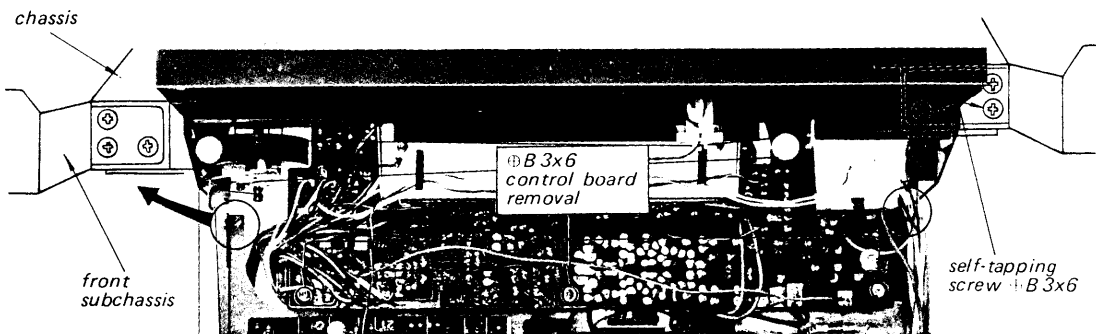

Fig. 2-15. Front subchassis removal (1)

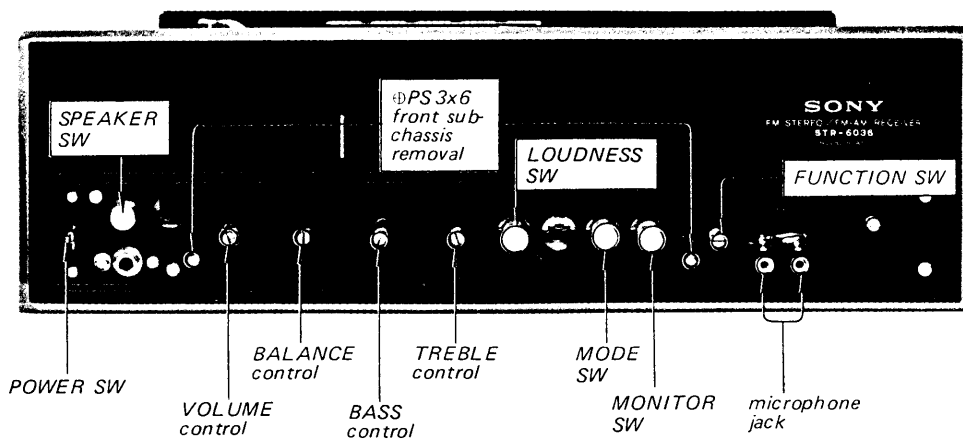

Fig. 2-16. Front subchassis removal (2)

Procedure

1. Remove the three screws securing the control board to the chassis as shown in Fig. 2-15.
2. Remove the three self-tapping screws at each side of front subchassis securing it to the chassis as shown in Fig. 2-15.
3. Remove the two screws securing the front subchassis to the control bracket and two microphone jacks as shown in Fig. 2-16. This frees control board.
4. Remove the five hex nuts and five screws securing all the controls and switches to the control bracket as shown in Fig. 2-17.
5. Remove the three screws securing the control bracket to the control board as shown in Fig. 2-17. This frees control bracket.
6. With a soldering iron having a solder-sucking tip, clean the solder from each lug of the defective switches or controls and the printed circuit board.
7. Remove the defective component and then install a new one.

2-9. POWER TRANSISTOR REPLACEMENT

1. Remove the wooden case as described in Procedure 2-3.

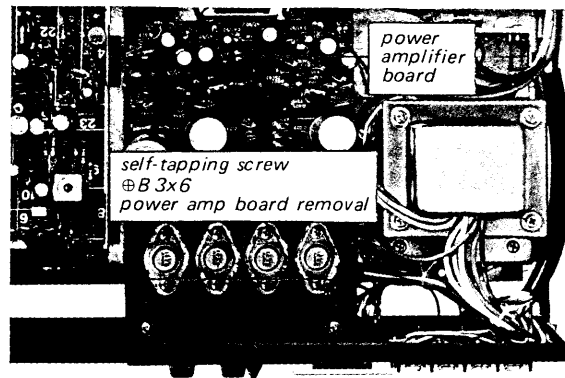

Fig. 2-18. Power amplifier board removal

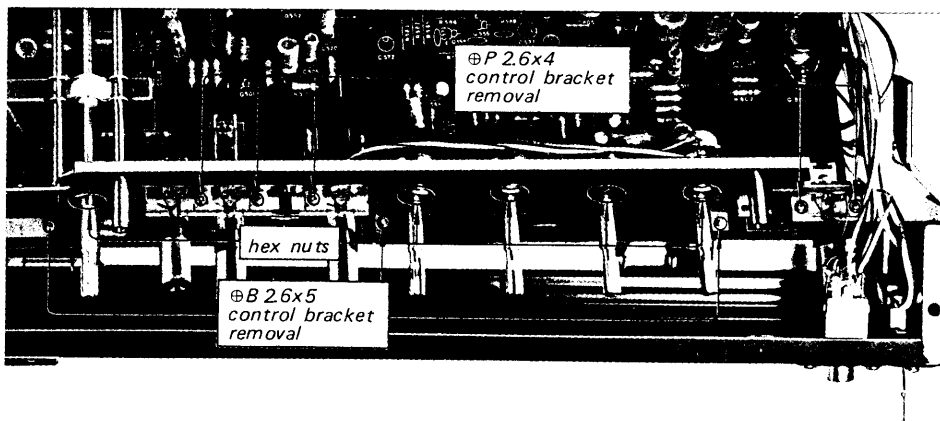

Fig. 2-17. Control bracket removal

2-10. REAR PANEL REMOVAL

1. Remove the power amplifier PCB as described in Procedure 2-9.
2. Remove the two self-tapping screws at each side of the rear panel securing it to the chassis as shown in Fig. 2-19.

2-11. REPLACEMENT OF COMPONENTS SECURED TO THE REAR PANEL BY RIVETS

1. Remove the rear panel as described in Procedure 2-10.
2. Bore out the rivets using a drill bit slightly larger in diameter than the rivet. See Fig. 2-20.
3. Punch out the remainder of the rivet with a nail set or prick punch.
4. Remove the defective component, and then install a new one.

5. Secure the new component with a suitable screw and nut, or repair rivet screw (Part Number 3-701-402).

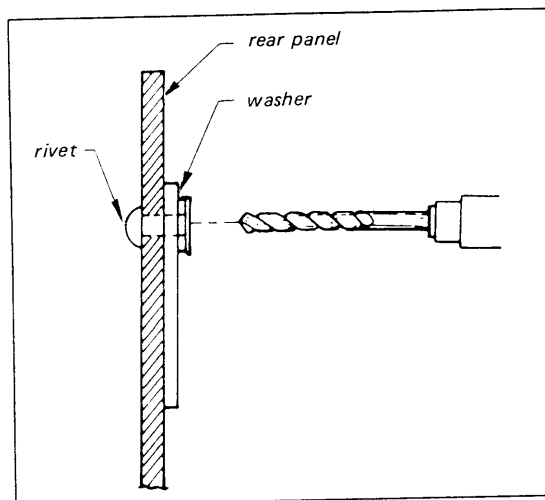

Fig. 2-20. Rivet removal

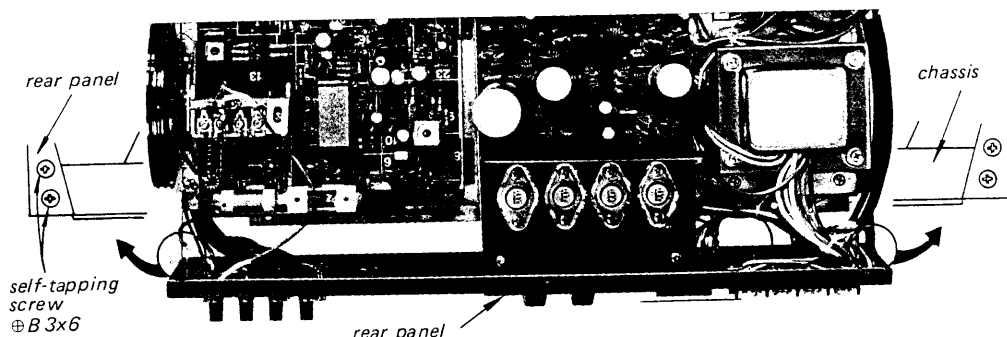
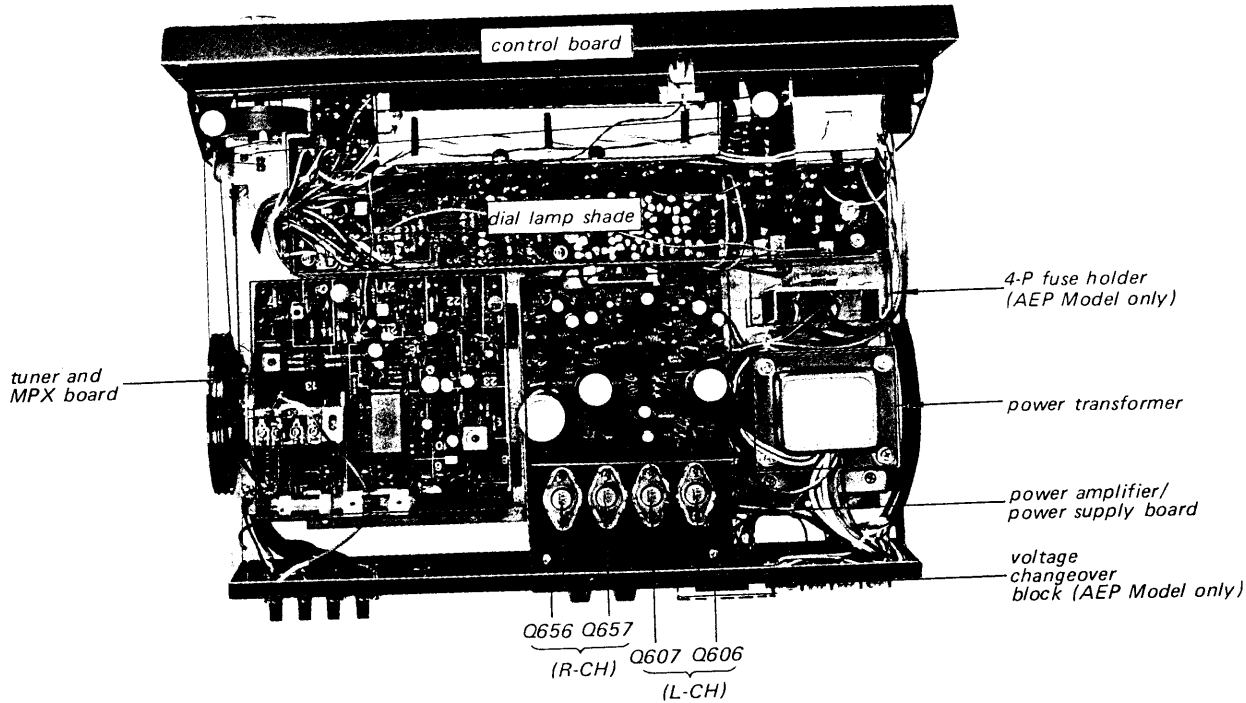

Fig. 2-19. Rear panel removal

2-12. CHASSIS LAYOUT



SECTION 3 ALIGNMENT AND ADJUSTMENT PROCEDURES

3-1. FM I-F AND DISCRIMINATOR ALIGNMENT

CAUTION

The ceramic filters in the fm i-f circuit are selected according to their specified center frequencies and color coded as shown in Fig. 3-1 and listed in Table 3-1. Check the color code of the filters to identify the same center frequency when replacing any of these filters.

TABLE 3-1.
FM I-F CERAMIC FILTERS

Part No.	Color	Specified Center Freq.
1-527-507-11	red	10.70 MHz
1-527-507-21	black	10.66 MHz
1-527-507-31	white	10.74 MHz
1-527-507-41	green	10.62 MHz
1-527-507-51	yellow	10.78 MHz

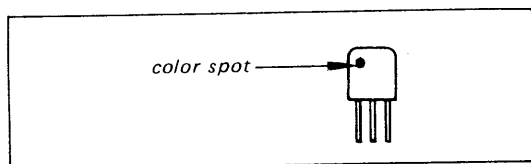

Fig. 3-1. Color dot on ceramic filter

Note: Two methods of i-f discriminator alignment are available, sweep generator alignment and signal generator alignment. You can use either of them. In either case, the local oscillator should be killed. To stop the local oscillator's operation, remove the shield cover over the local oscillator capacitor, if necessary, and then shunt the oscillator capacitor with a 0.02μF capacitor. See Fig. 3-2.

Sweep Generator Alignment

Test Equipment Required

1. 10.7 MHz sweep generator
2. Oscilloscope
3. Ceramic capacitor, 0.02μF
4. Alignment tools

Preparation

1. Connect the input cable of the oscilloscope with alligator clips to R221 and ground on the tuner and MPX board, and solder a 0.02μF capacitor across these clips, as shown in Fig. 3-3.
2. Connect the output cable of the sweep generator across CV102 on tuner and MPX board. Use alligator clips and make the connection through a 0.02μF coupling capacitor as shown in Fig. 3-4.

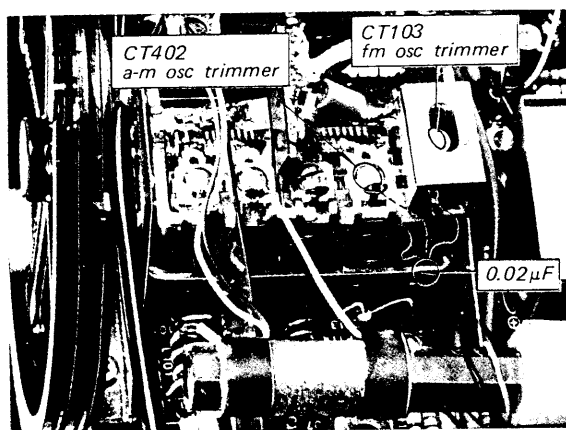

Fig. 3-2. Interruption of fm or a-m local oscillator

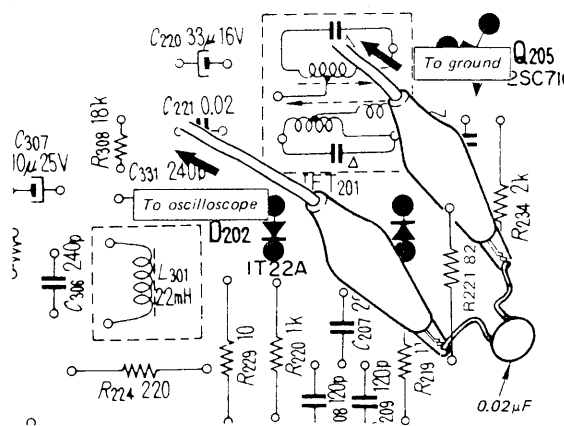

Fig. 3-3. Fm discriminator output connection

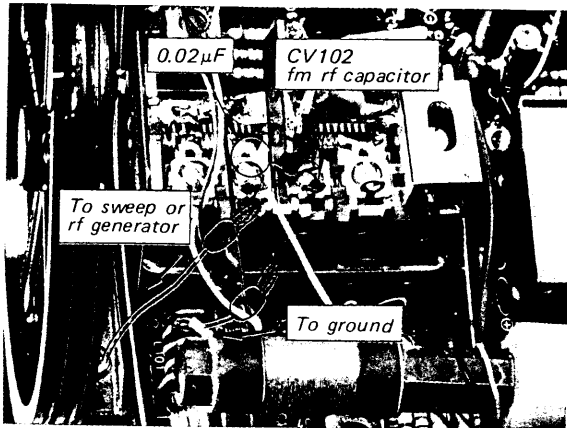

Fig. 3-4. 10.7 MHz signal injection

Procedure

1. With the equipment connected as shown in Fig. 3-5, set the sweep generator's controls as follows:
 - Center frequency Specified frequency of ceramic filter. See Table 3-1.
 - Sweep width 1 MHz
2. Set the receiver's controls as follows:
 - FUNCTION switch . . . FM AUTO STEREO
 - VOLUME control . . . Minimum
3. Adjust the oscilloscope controls to provide a visible indication:

Note: Two or three traces will be observed on the oscilloscope as the center frequency of the sweep generator varies. The trace you are looking for has the largest amplitude. Once you get it, decrease the sweep generator output low enough to obtain rather noisy output.
4. Turn the top core (secondary side) of discriminator transformer IFT201 (see Fig. 3-10) with an alignment tool to obtain the "S" curve response, and equalize the positive and negative peaks of the "S" curve response, as shown in Fig. 3-6.

5. Adjust i-f transformer IFT101 (see Fig. 3-10) and primary side of discriminator transformer (IFT201 bottom core) to obtain a maximum-amplitude "S" curve response.

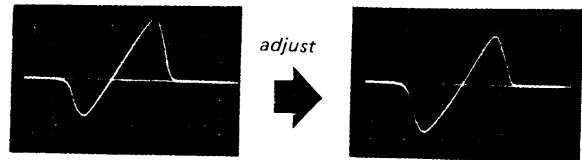

Fig. 3-6. "S" curve response

Signal Generator Alignment

Test Equipment Required

1. Standard signal generator which can generate a 10.7-MHz a-m/fm signal.
 - Vertical sensitivity 100mV/cm minimum
2. Oscilloscope
3. Alignment tools

Preparation

Same as described for the sweep generator method.

Procedure

1. With the equipment connected as shown in Fig. 3-7, set the signal-generator's controls as follows:
 - Frequency Specified frequency of ceramic filter. See Table 3-1.
 - Modulation Fm, 400 Hz, 100% (75 kHz)
 - Output level 10,000μV (80 dB)
2. Set the receiver's controls as follows:
 - FUNCTION switch . . . FM AUTO STEREO
 - VOLUME control . . . Minimum

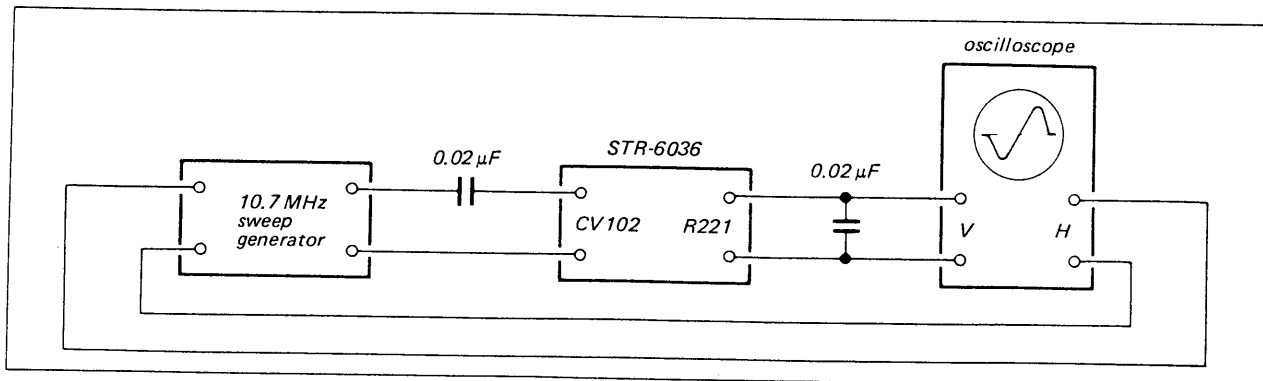

Fig. 3-5. Test setup for discriminator alignment by sweep generator

3. Adjust the signal generator's frequency slightly to obtain a maximum output, and then change the signal generator's modulation to a-m, 400 Hz 30%.
4. If the discriminator transformer IFT201 (see Fig. 3-10) is not aligned correctly, 400-Hz ripple will be observed as shown in Fig. 3-8.
5. Turn the top core of discriminator transformer IFT201 with an alignment tool to obtain a minimum indication on the oscilloscope as shown in Fig. 3-8.

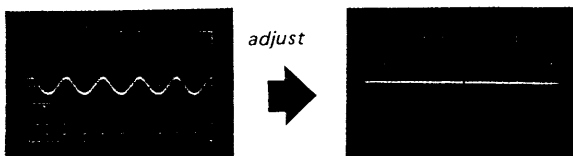

Fig. 3-8. Fm discriminator alignment output response

Note: Turn the core carefully and slowly because the output appearing on the oscilloscope jumps up and down when turning the core. This might cause difficulty in determining the point of minimum output.

Also, at both extreme positions of the top core, decreased output will be observed. The real null point should be obtained in the middle of the core thread length, and maximum output occurs at each side of the true null point.

6. Change the signal generator's modulation to fm, 400 Hz 100% (75 kHz).
7. Turn the core of fm IFT101 (see Fig. 3-10),

and the primary side of discriminator transformer IFT201 to obtain the maximum output.

3-2. FM FREQUENCY COVERAGE AND TRACKING ALIGNMENT

Note: Before starting this alignment, the discriminator-transformer alignment should be performed.

Test Equipment Required

1. Standard fm signal generator
2. Ac VTVM
3. Alignment tools

Preparation

1. Connect the equipment as shown in Fig. 3-9.
2. Set the receiver's controls as follows:

FUNCTION switch FM AUTO STEREO
VOLUME control Minimum

Generator Alignment

Follow the procedures given in Table 3-2 when performing this alignment with an fm signal generator. Be sure that the dial is mechanically calibrated.

Off-the-Air Alignment

Accurate dial calibration and a frequency-coverage test can also be performed by utilizing off-the-air local fm signals. However, before performing the following procedure, be sure that the dial is mechanically calibrated.

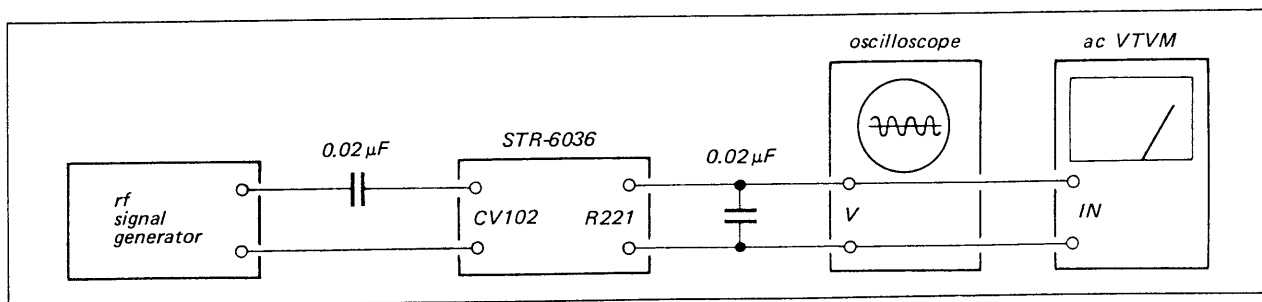

Fig. 3-7. Test setup for fm discriminator alignment by rf signal generator

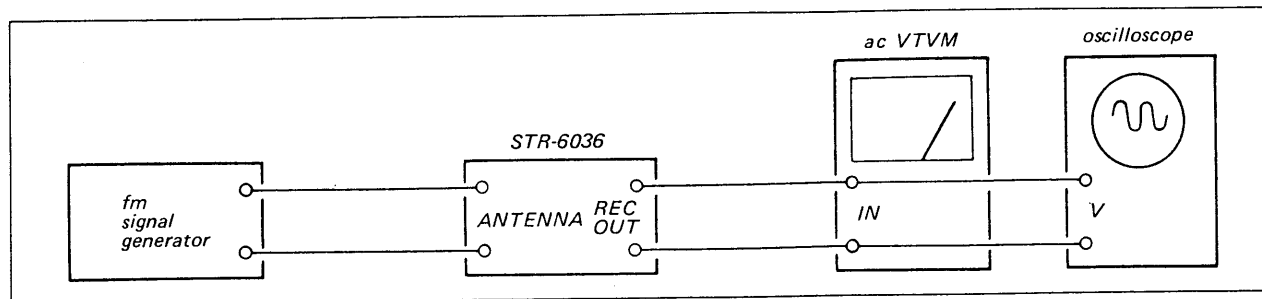

Fig. 3-9. Fm frequency coverage and tracking alignment test setup

TABLE 3-2. FM FREQUENCY COVERAGE AND TRACKING ALIGNMENT

FREQUENCY COVERAGE ALIGNMENT					
Step	Coupling Between Receiver and SSG	SSG Frequency and Output Level	Tuner Dial Indication	Adjust	Indication
1.	Direct coupling	87.5 MHz 400 Hz 100% mod. 10µV (20 dB)	lowest position	OSC coil L103 See Fig. 3-10	Maximum VTVM reading
2.	Same as above	108.4 MHz 400 Hz 100% mod. 10µV (20 dB)	highest position	OSC trimmer CT103 See Fig. 3-10	Same as above
TRACKING ALIGNMENT					
1.	Direct coupling	87.5 MHz 400 Hz 100% mod. 10µV (20 dB)	lowest position	Antenna coil L101 RF coil L102 See Fig. 3-10	Maximum VTVM reading
2.	Same as above	108.4 MHz 400 Hz 100% mod. 10µV (20 dB)	highest position	Antenna trimmer CT101 RF trimmer CT102 See Fig. 3-10	Same as above

Adjusting Parts Location

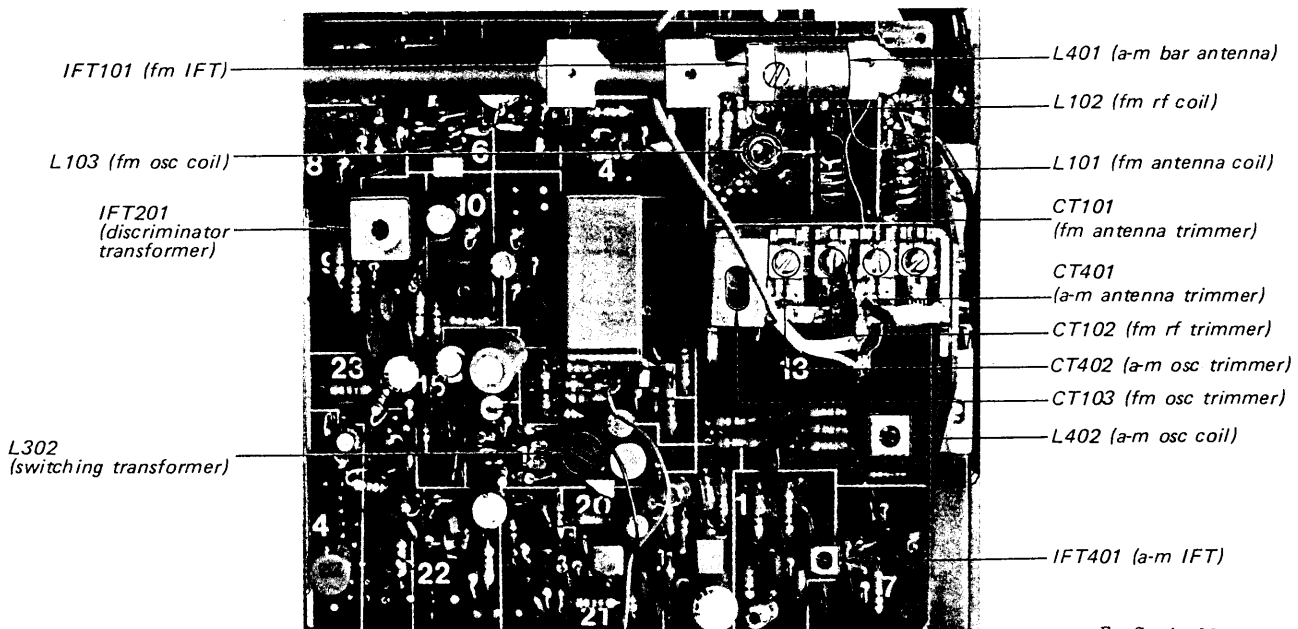

Fig. 3-10. Adjusting parts location

For Service Manuals
MAURITRON SERVICES
 8 Cherry Tree Road, Chinnor
 Oxfordshire, OX9 4QY.
 Tel (01844) 351694
 Fax (01844) 352554
 email:- sales@mauritron.co.uk

3-3. A-M I-F STRIP ALIGNMENT

Preparation

Set the receiver's FUNCTION switch to AM.

Note: To perform this alignment, the local oscillator should be killed. To do this, shunt the local oscillator capacitor CV402 with a 0.02 μ F ceramic capacitor as shown in Fig. 3-2.

Sweep Generator Alignment

Test Equipment Required

1. Sweep generator, 455 kHz.
2. Oscilloscope
3. Alignment tools

Procedure

1. Connect the sweep generator's output directly to the AM EXT ANT terminal.
2. Connect the input cable of the oscilloscope with alligator clips to the connection point of R418 and R419 and ground on the tuner and MPX board as shown in Fig. 3-11.
3. Set the sweep generator's control as follows:
 - Center frequency 455 kHz
 - Sweep width 25 kHz
 - Output as low as possible
4. With the equipment connected as shown in Fig. 3-12, adjust the oscilloscope controls and generator output to provide a visible indication.

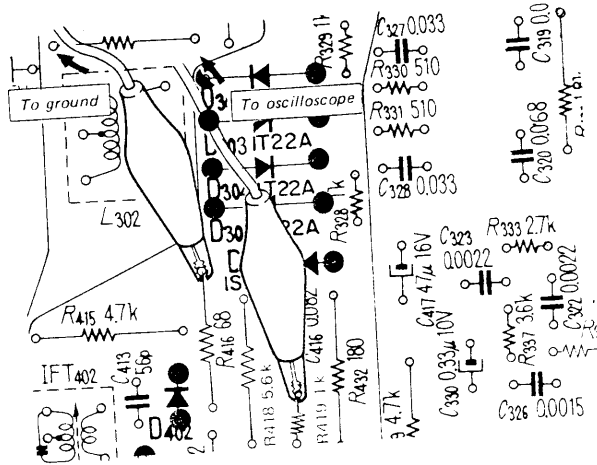

Fig. 3-11. A-m detector output connection

5. Turn the top core of a-m IFT401 (see Fig. 3-10) to obtain a maximum and symmetrical response as shown in Fig. 3-13.

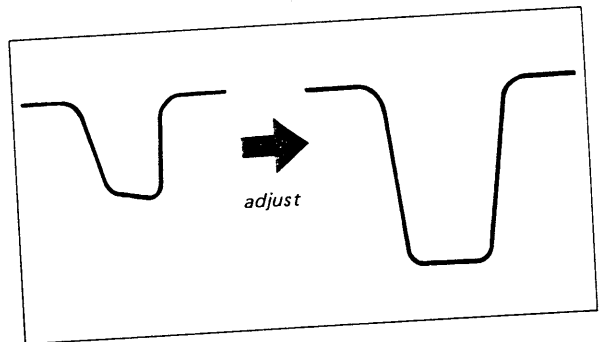

Fig. 3-13. A-m i-f response

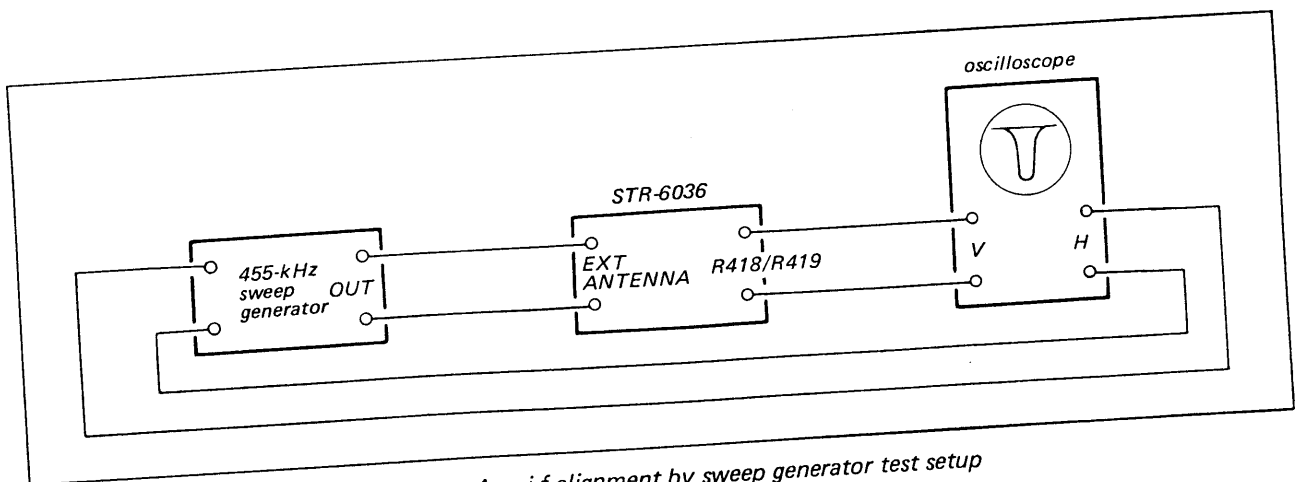

Fig. 3-12. A-m i-f alignment by sweep generator test setup

Rf Signal Generator Method

Test Equipment Required

- 1. Signal generator, a-m modulation
- 2. Oscilloscope
- 3. Alignment tools

Procedure

- 1. Set the rf signal generator's controls as follows:
ModulationINTERNAL
Frequency.....455 kHz
OUTPUT level..... 1,000 μ V (60 dB)

- 2. Connect the rf signal-generator's output to the AM EXT ANT terminal.
- 3. With the equipment connected as shown in Fig. 3-14, turn the top core of a-m IFT401 (see Fig. 3-10) to obtain the maximum output.

3-4. A-M FREQUENCY COVERAGE AND TRACKING ALIGNMENT

Preparation

Remove the wooden case as described in Procedure 2-3. Then, set the receiver's FUNCTION switch to AM.

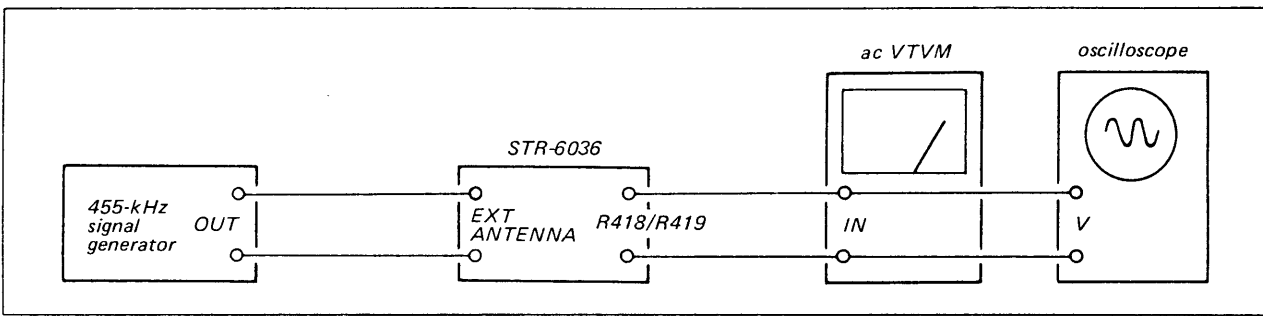

Fig. 3-14. Test setup for a-m i-f alignment by rf signal generator

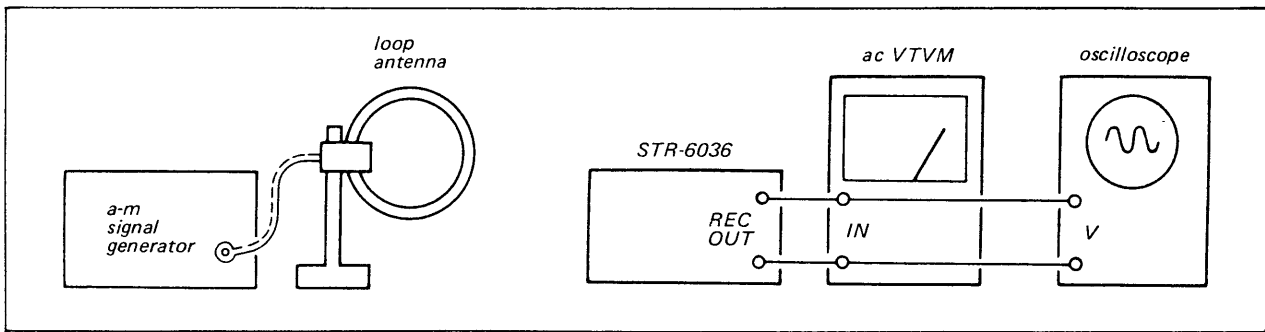

Fig. 3-15. A-m frequency coverage and tracking alignment test setup

Signal Generator Method

Test Equipment Required

1. Signal generator
2. Loop antenna
3. Ac VTVM

Procedure

With the equipment connected as shown in Fig. 3-15, follow the procedures given in Table 3-3 when performing this alignment with an a-m signal generator.

Off-the-Air Signal Method

Accurate dial calibration, and a frequency-coverage and tracking test can also be performed by utilizing off-the-air local a-m signals. However, before performing the following procedure, be sure that the dial is mechanically calibrated.

TABLE 3-3. A-M FREQUENCY COVERAGE AND TRACKING ALIGNMENT

FREQUENCY COVERAGE ALIGNMENT				
SSG Coupling	SSG Frequency and Output Level	Tuner Dial Indication	Adjust	Indication
Loop antenna	550 kHz 400 Hz 30% mod. 10,000 μ V (80 dB)	550 kHz	OSC coil L402 See Fig. 3-10	Maximum VTVM reading
Loop antenna	1,600 kHz Same as above	1,600 kHz	OSC trimmer CT402 See Fig. 3-10	Same as above
TRACKING ALIGNMENT				
Loop antenna	620 kHz 400 Hz 30% mod. Output level as low as possible	620 kHz	Position of antenna coil L401 See Fig. 3-10	Maximum VTVM reading
Loop antenna	1,400 kHz Same as above	1,400 kHz	Antenna trimmer CT401 See Fig. 3-10	Same as above

MEMO

A series of horizontal dotted lines for writing a memo.

**SECTION 4
REPACKING**

The STR-6036's original shipping carton and packing materials are the ideal containers for shipping the unit. However to secure the maximum protection,

the STR-6036 must be repacked in these materials precisely as before. The proper repacking procedures are shown in Fig. 4-1.

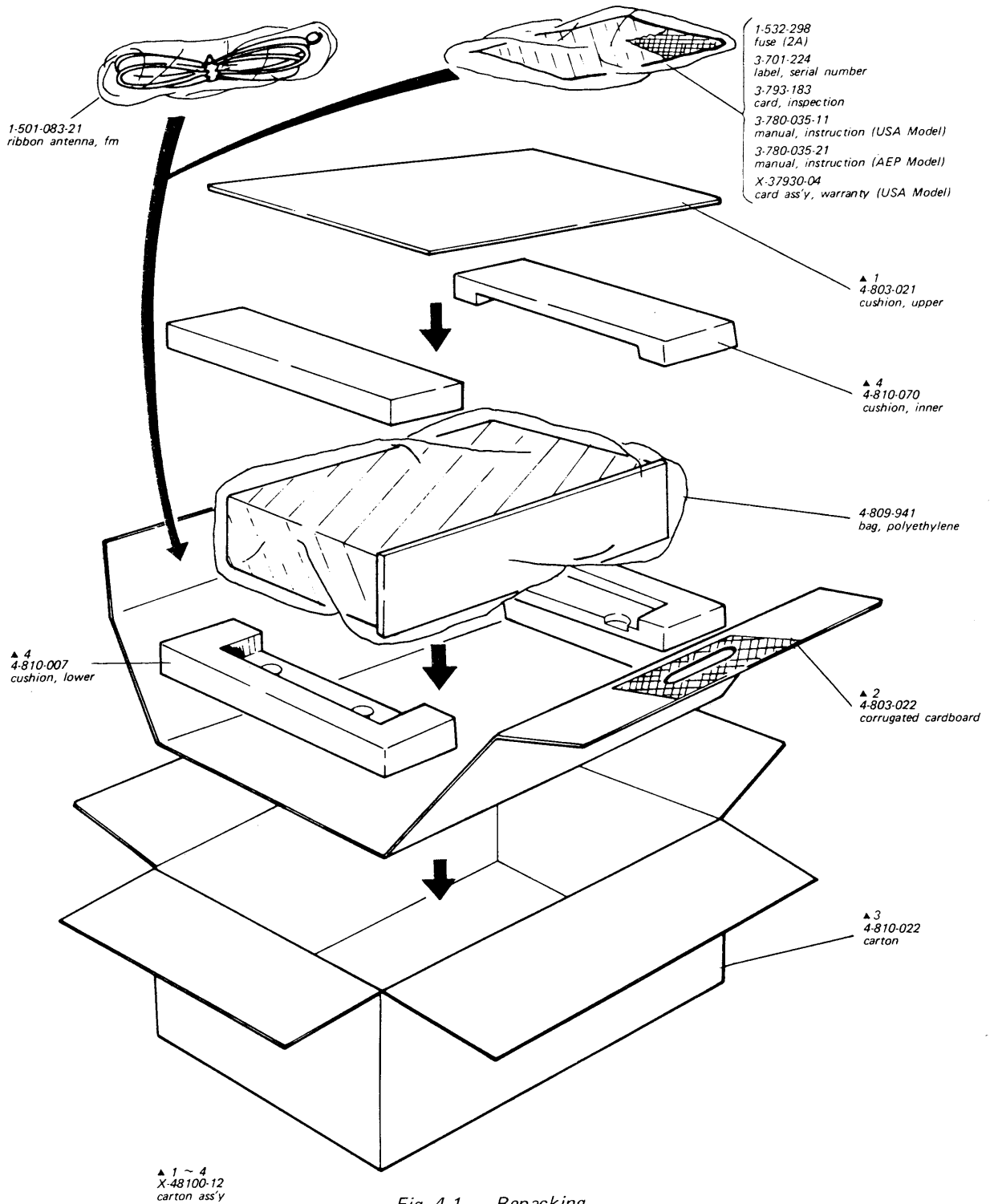
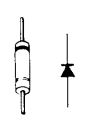
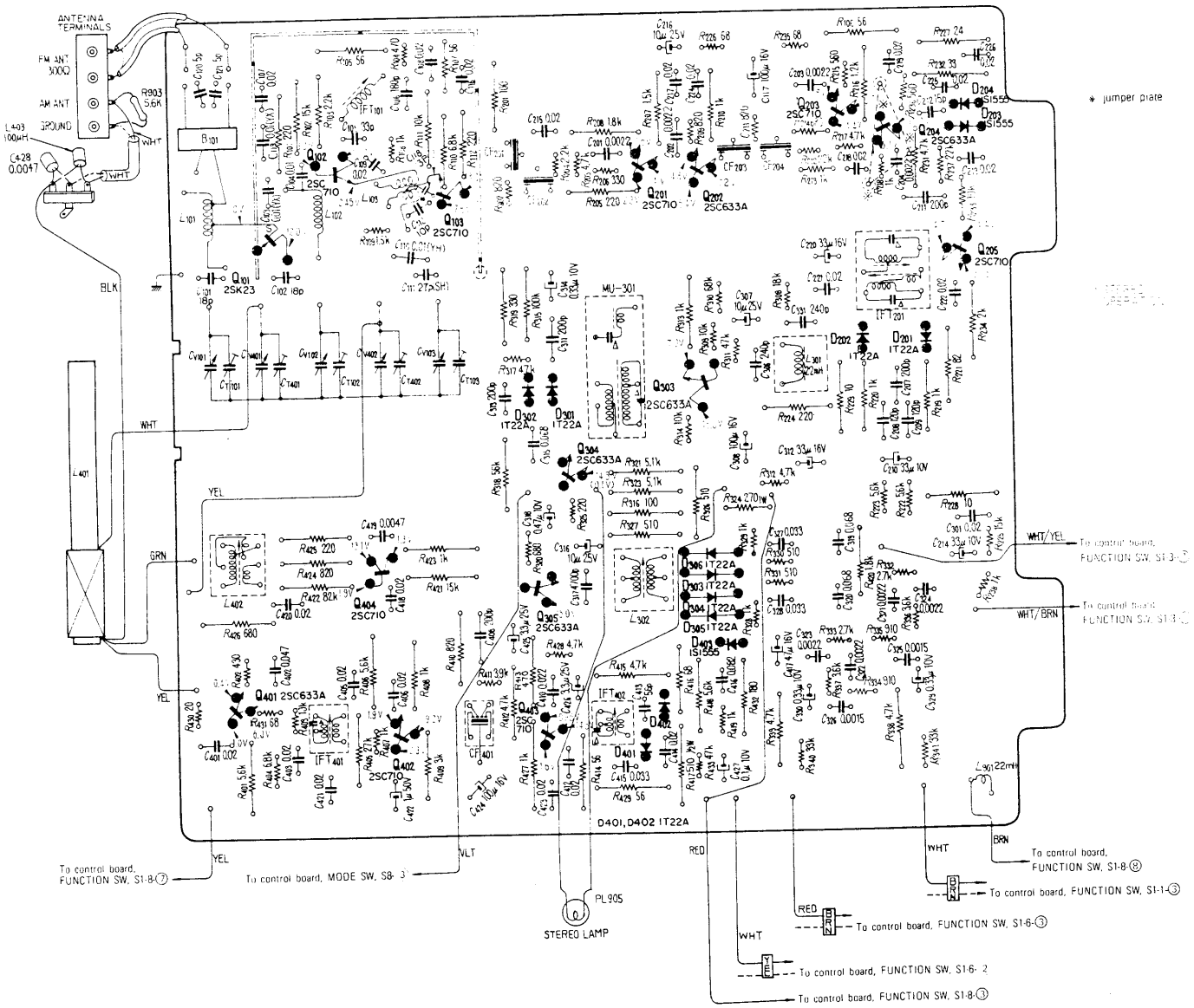

Fig. 4-1. Repacking

**SECTION 5
DIAGRAMS**

**5-1. MOUNTING DIAGRAM – Fm (A-m) Front End/I-f Amp/MPX Board –
– Conductor Side –**



**1T22A
1S1555**

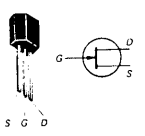

2SK23

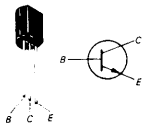

2SC710

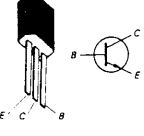

2SC633A

**For Service Manuals
MAURITRON SERVICES
8 Cherry Tree Road, Chinnor
Oxfordshire, OX9 4QY.
Tel (01844) 351694
Fax (01844) 352554
email:- sales@mauritron.co.uk**

5-2. MOUNTING DIAGRAM — Power Amplifier/Power Supply Board — — Conductor Side —

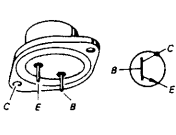
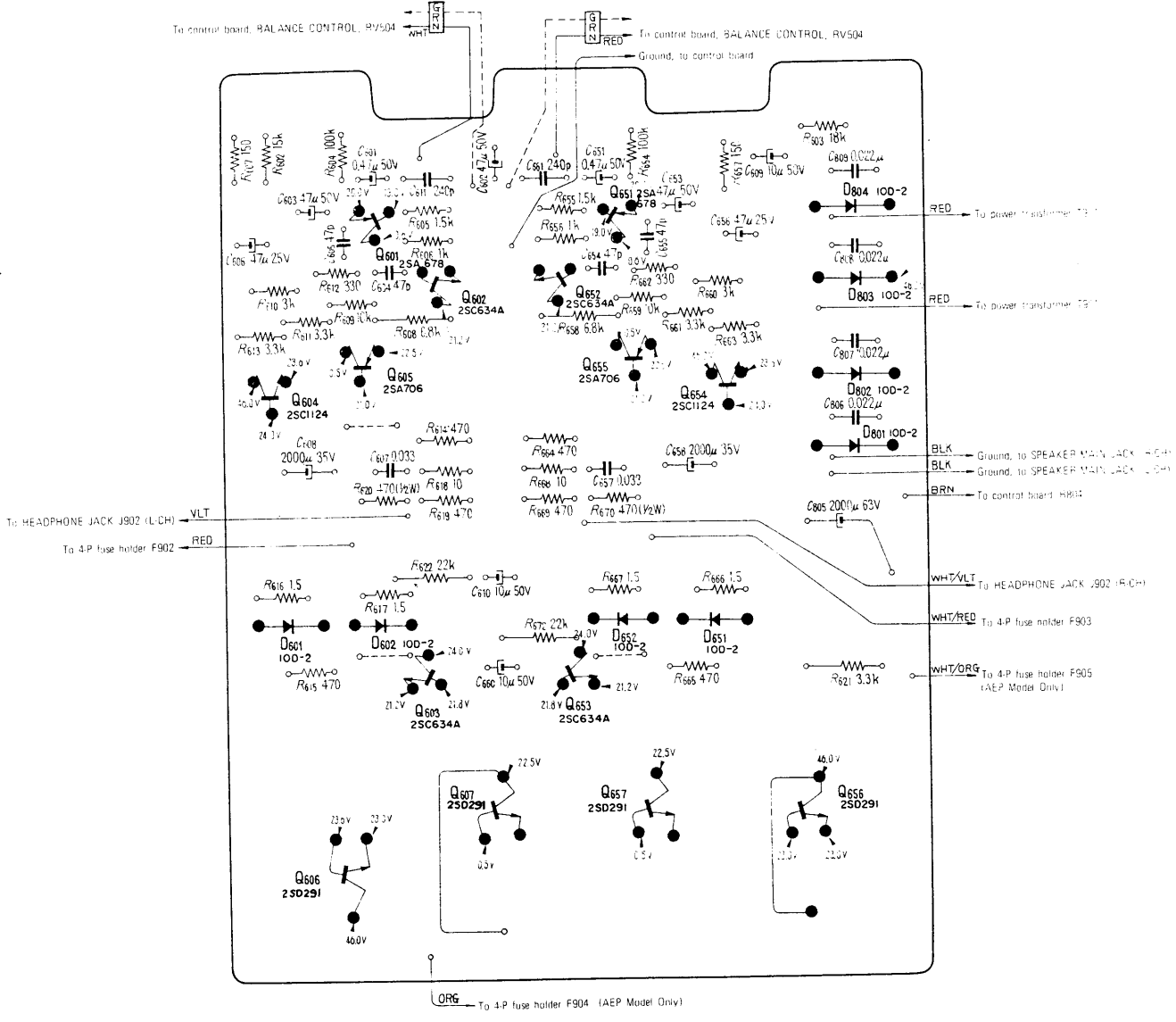

2SD291

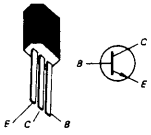

2SC634A

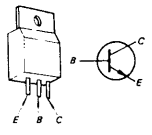

2SC1124

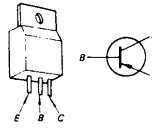

2SA706

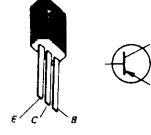

2SA678



10D-2

5-3. MOUNTING DIAGRAM — Control Board —

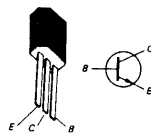
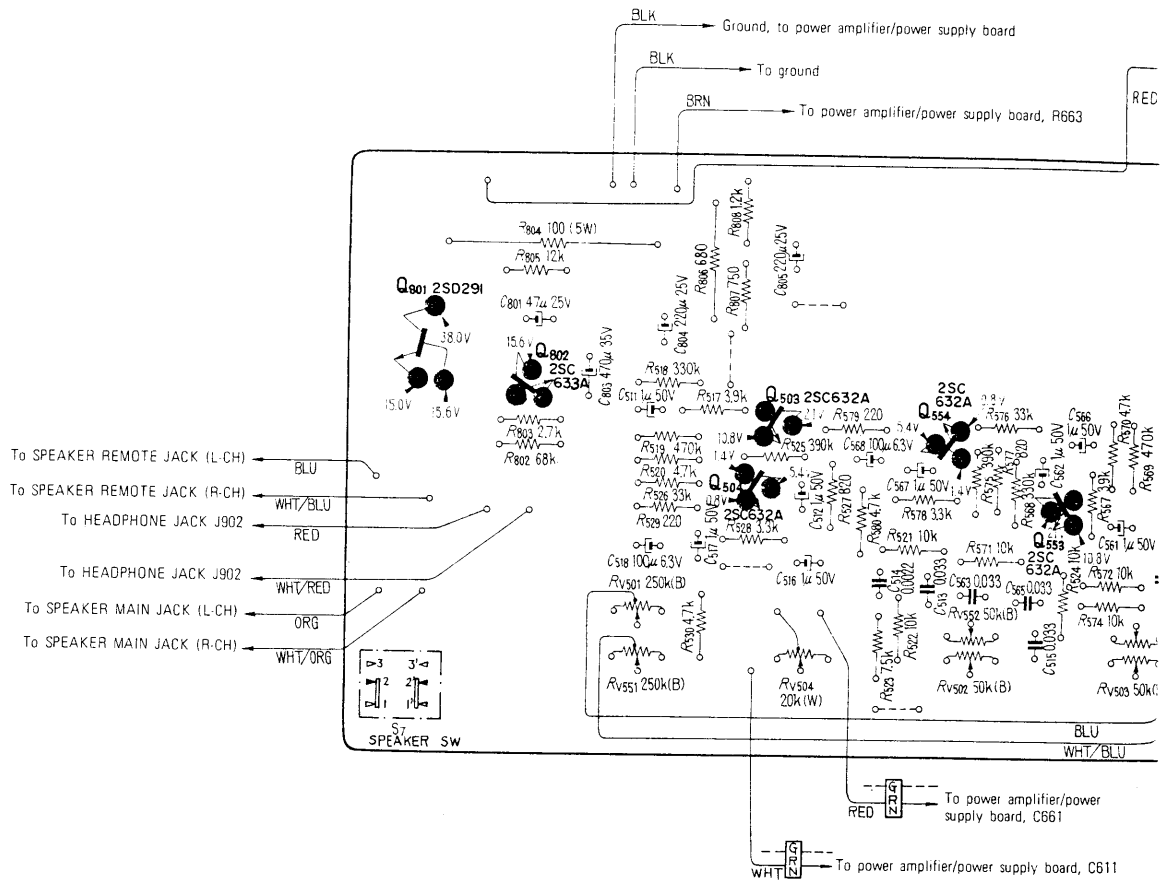

2SC631A
2SC632A
2SC633A

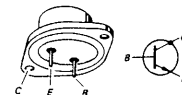

2SD291

Control Board —

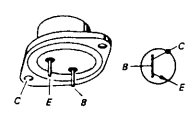
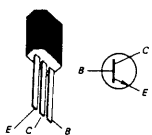
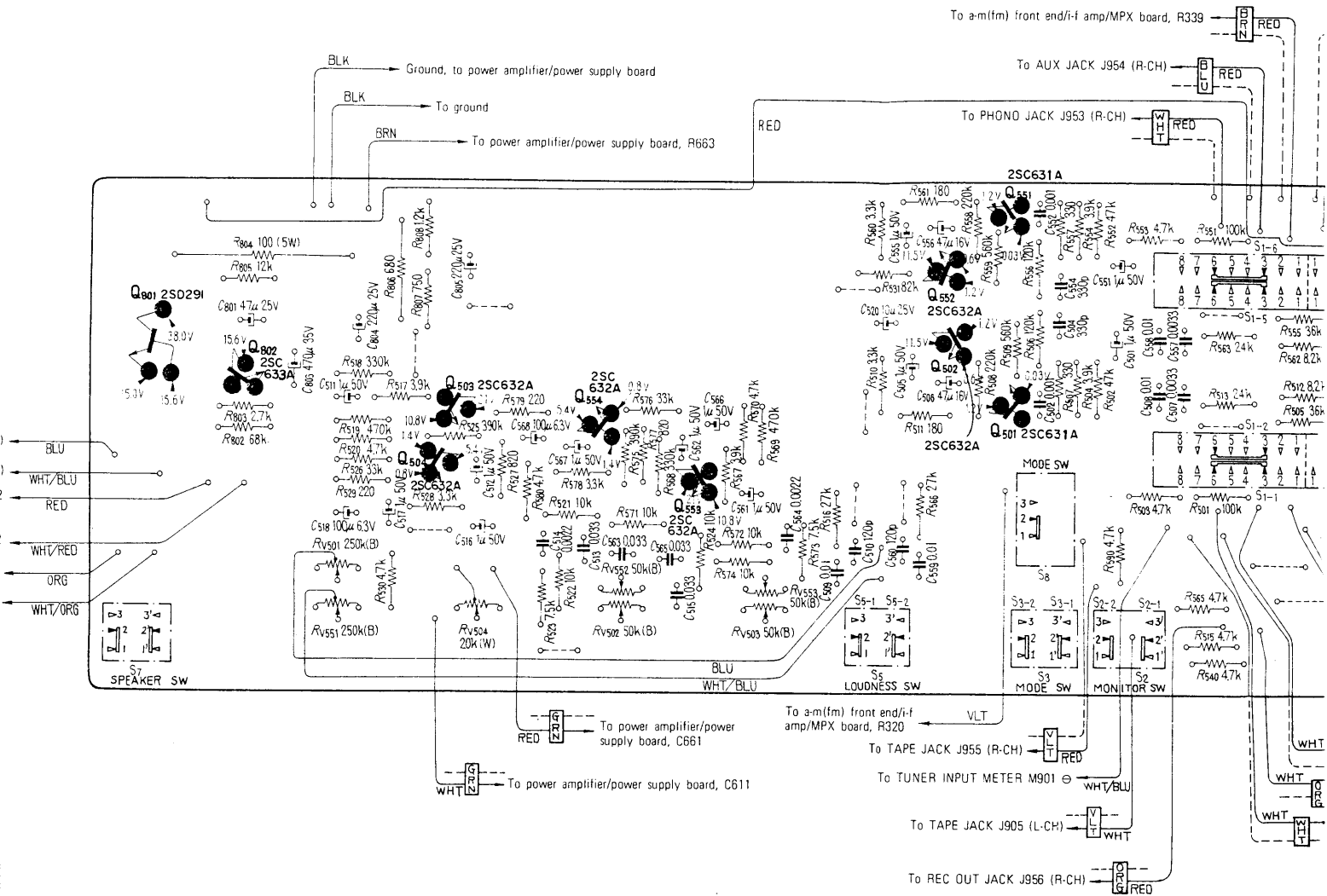

2SC631A
2SC632A
2SC633A

2SD291

54. SCHEMATIC DIAGRAM

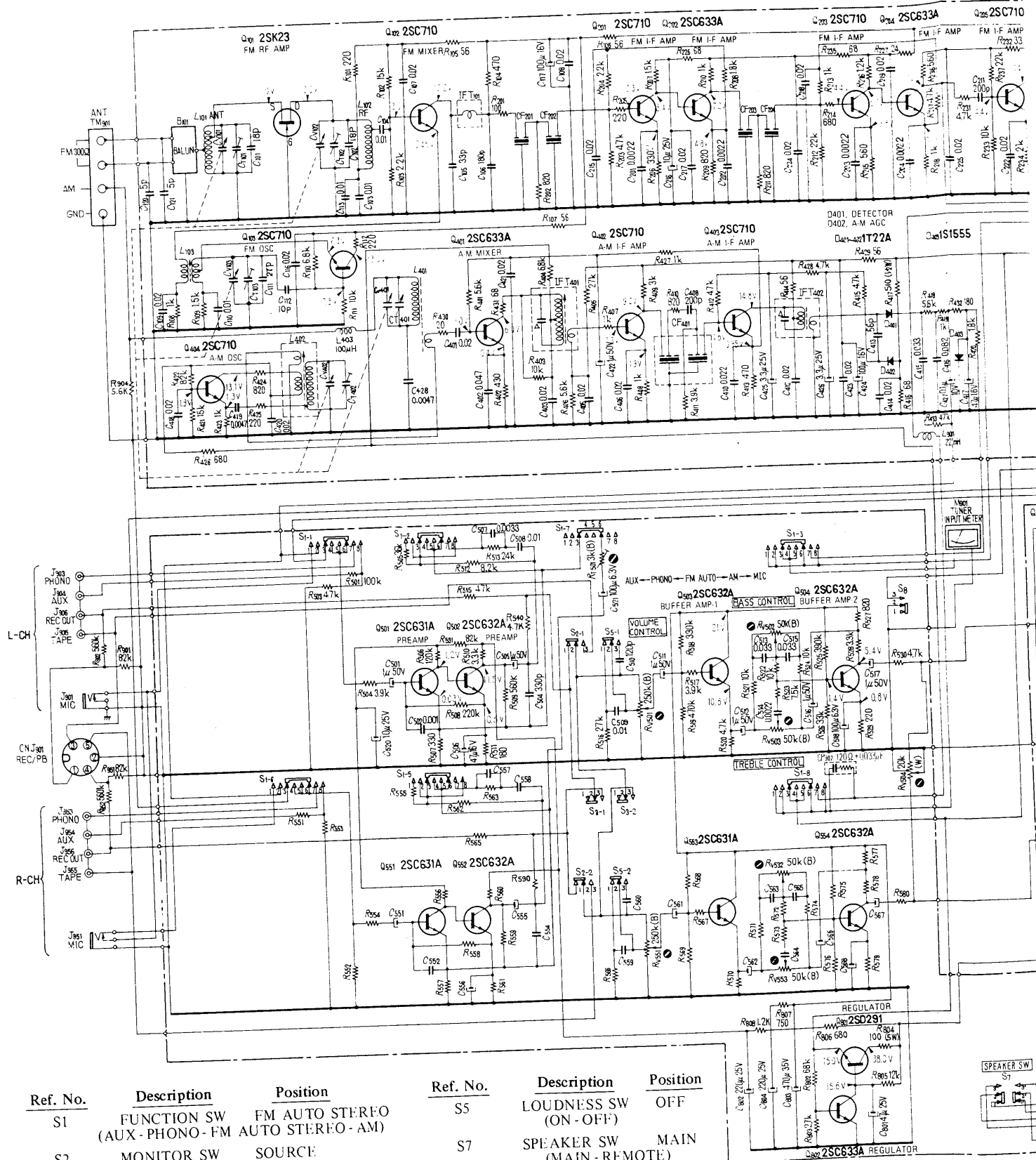

Ref. No.	Description	Position	Ref. No.	Description	Position
S1	FUNCTION SW (AUX - PHONO - FM AUTO STEREO - AM)	FM AUTO STEREO	S5	LOUDNESS SW (ON - OFF)	OFF
S2	MONITOR SW (SOURCE - TAPE)	SOURCE	S7	SPEAKER SW (MAIN - REMOTE)	MAIN
S3 (S8)	MODE SW (STEREO - MONO)	STEREO	S901	POWER SW (ON - OFF)	OFF

STR-6036 STR-6036

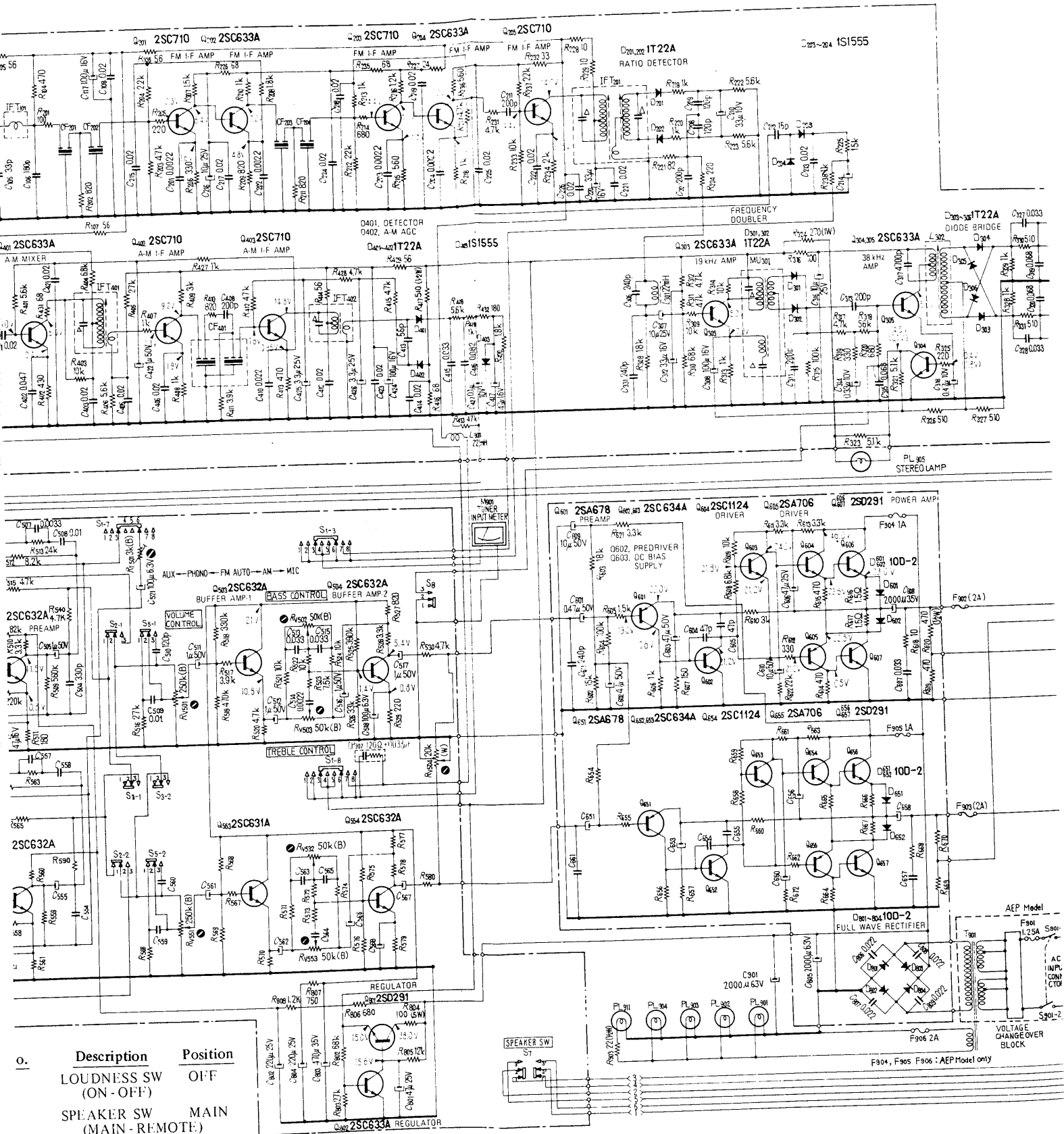

Description	Position
LOUDNESS SW (ON - OFF)	OFF
SPEAKER SW (MAIN - REMOTE)	MAIN
POWER SW (ON - OFF)	OFF

For Service Manuals
MAURITRON SERVICES
 8 Cherry Tree Road, Chinnor
 Oxfordshire, OX9 4QY.
 Tel (01844) 351694
 Fax (01844) 352554
 mail:- sales@mauritron.co.uk

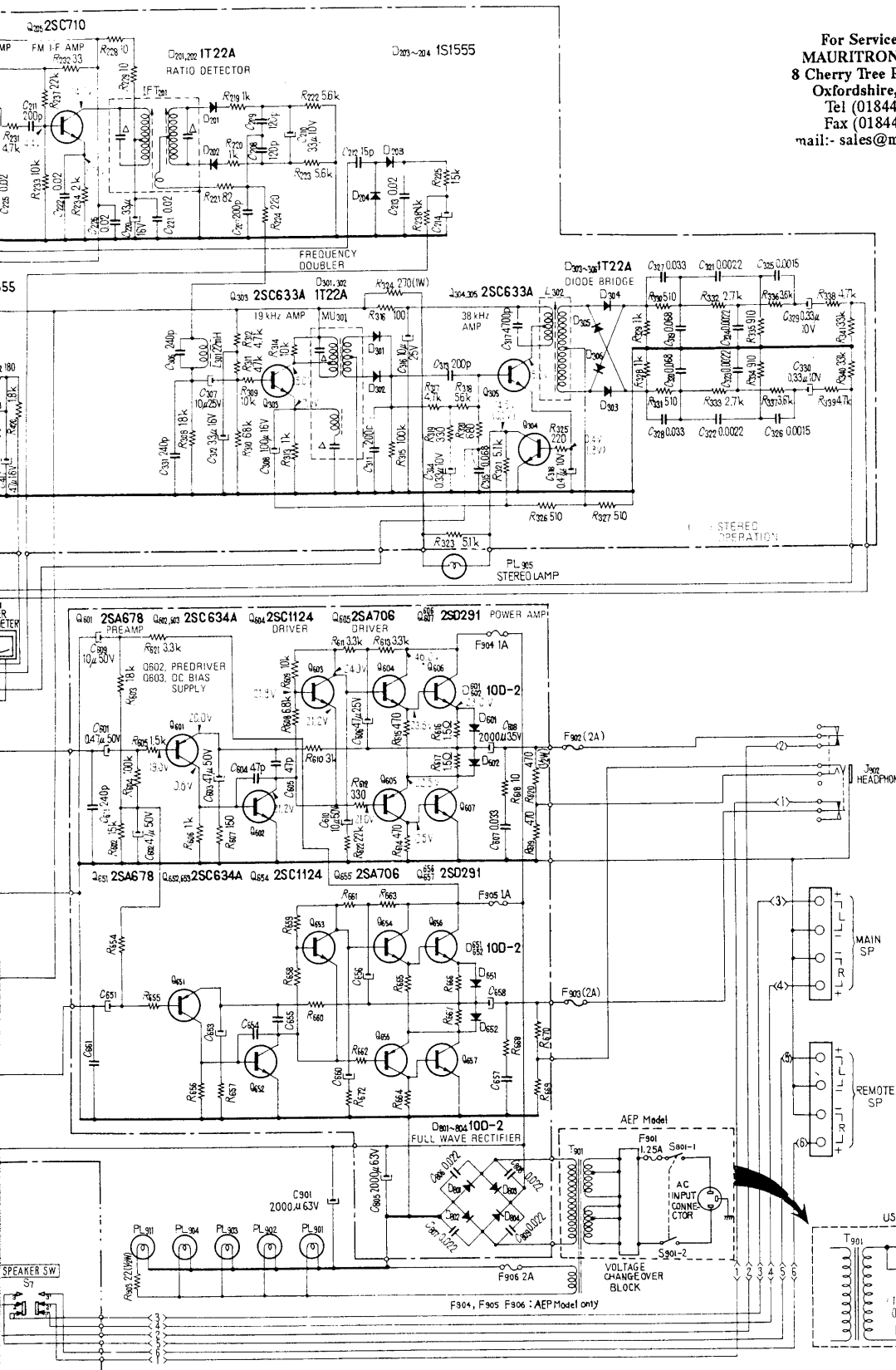

Note:
 All resistance values are in ohms.
 k = 1,000, M = 1,000 k
 All capacitance values are in μF
 except as indicated with p, which
 means μF .
 All voltages represent an average
 value and should hold within $\pm 10\%$.
 All voltages are dc measured with a
 VOM which has an input impedance
 of 20k ohms/volt. No signal in.

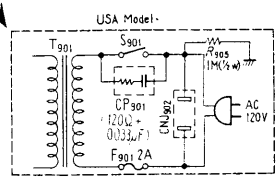

SONY
STR-6036

© 1971

**SECTION 6
EXPLODED VIEW**

(1) The following chart will help you to decipher the hardware codes given in the exploded view.

— Hardware Nomenclature —

P – Pan Head Screw		SC – Set Screw	
PS – Pan Head Screw with Spring Washer		E – Retaining Ring (E Washer)	
K – Flat Countersunk Head Screw		W – Washer	
B – Binding Head Screw		SW – Spring Washer	
RK – Oval Countersunk Head Screw		LW – Lock Washer	
T – Truss Head Screw		N – Nut	
R – Round Head Screw			
F – Flat Fillister Head Screw			

— Example —

Type of Slot
 \oplus P 3x10
 Length in mm (L)
 Diameter in mm (D)
 Type of Head

(2) To simplify the exploded view, the part numbers of normal screws, nuts, washers, and retaining rings are not expressed but summarized in the table below.

<u>Part No.</u>	<u>Description</u>	<u>Part No.</u>	<u>Description</u>
7-621-259-25	screw, \oplus P 2.6 x 4	7-682-548-01	screw, \oplus B 3 x 8
7-621-771-34	screw, \oplus B 2.6 x 5	7-682-549-13	screw, \oplus B 3 x 10
7-623-108-17	washer, 3 mm dia.	7-682-565-01	screw, \oplus B 4 x 16
7-623-207-21	washer, spring 2.6 mm dia.	7-682-646-01	screw, \oplus PS 3 x 5
7-623-208-27	washer, spring 3 mm dia.	7-682-647-01	screw, \oplus PS 3 x 6
7-623-408-01	washer, lock (external tooth) 3 mm dia.	7-682-648-01	screw, \oplus PS 3 x 8
7-623-508-01	lug, 3 mm dia.	7-682-949-01	screw, \oplus PSW 3 x 10
7-623-616-00	eyelet, 2 x 3	7-682-961-01	screw, \oplus PSW 4 x 8
7-624-109-01	retaining ring, 5 mm dia.	7-684-013-01	nut, 3 mm dia.
7-682-145-01	screw, \oplus P 3 x 4	7-684-023-00	nut, 3 mm dia.
7-682-247-01	screw, \oplus K 3 x 6	7-685-245-21	screw, self-tapping \oplus K 3 x 6
7-682-545-01	screw, \oplus B 3 x 4	7-685-545-21	screw, self-tapping \oplus B 3 x 6
7-682-546-01	screw, \oplus B 3 x 5	7-685-546-21	screw, self-tapping \oplus B 3 x 8
7-682-547-01	screw, \oplus B 3 x 6	7-685-548-21	screw, self-tapping \oplus B 3 x 12

For Service Manuals
MAURITRON SERVICES
 8 Cherry Tree Road, Chinnor
 Oxfordshire, OX9 4QY.
 Tel (01844) 351694
 Fax (01844) 352554
 email:- sales@mauritron.co.uk

SECTION 7 ELECTRICAL PARTS LIST

<u>Ref. No.</u>	<u>Part No.</u>	<u>Description</u>	<u>Ref. No.</u>	<u>Part No.</u>	<u>Description</u>			
MOUNTED CIRCUIT BOARDS			Q501 (Q551)		transistor, 2SC631A			
8-982-619-10	a-m (fm) front-end/i-f amplifier/MPX circuit board (TCB-011 BW5C)		Q502 (Q552)		transistor, 2SC632A			
8-982-619-22	power amplifier/power supply circuit board (PCB-114)		Q503 (Q553)		transistor, 2SC631A			
8-982-619-05	control board (CCB-112)		Q504 (Q554)		transistor, 2SC632A			
SEMICONDUCTORS			Q601 (Q651)		transistor, 2SA678			
D201	diode, 1T22A		Q602 (Q652)		transistor, 2SC634A			
D202	diode, 1T22A		Q603 (Q653)		transistor, 2SC634A			
D203	diode, 1S1555		Q604 (Q654)		transistor, 2SC1124			
D204	diode, 1S1555		Q605 (Q655)		transistor, 2SA706			
D301	diode, 1T22A		Q606 (Q656)		transistor, 2SD291			
D302	diode, 1T22A		Q607 (Q657)		transistor, 2SD291			
D303	diode, 1T22A		Q801		transistor, 2SD291			
D304	diode, 1T22A		Q802		transistor, 2SC633A			
D305	diode, 1T22A		TRANSFORMERS, COILS AND INDUCTORS					
D306	diode, 1T22A		B101	1-417-025	balun			
D401	diode, 1T22A		IFT101	1-403-556-21	IFT, 10.7 MHz			
D402	diode, 1T22A		IFT201	1-403-291	transformer, discriminator 10.7 MHz			
D403	diode, 1S1555		IFT401	1-403-152	IFT, 455 kHz			
D601 (D651)	diode, 10D-2		IFT402	1-403-128	IFT, 455 kHz			
D602 (D652)	diode, 10D-2		L101	1-401-476	coil, fm antenna			
D801	diode, 10D-2		L102	1-425-710	coil, fm rf			
D802	diode, 10D-2		L103	1-405-495	coil, fm osc.			
D803	diode, 10D-2		L301	1-407-418	coil, SCA trap 22 mH			
D804	diode, 10D-2		L302	1-425-683	transformer, switching 38 kHz			
Q101	FET, 2SK23		L401	1-401-425	bar antenna, a-m			
Q102	transistor, 2SC710		L402	1-405-391	coil, a-m osc.			
Q103	transistor, 2SC710		L403	1-407-169	inductor, micro 100 μ H			
Q201	transistor, 2SC710		L901	1-407-408	inductor, micro 22 mH			
Q202	transistor, 2SC633A		MU301	1-425-548	MPX unit			
Q203	transistor, 2SC710		T901	1-441-806	transformer, power (AEP Model)			
Q204	transistor, 2SC633A			1-441-813	transformer, power (USA Model)			
Q205	transistor, 2SC710		CAPACITORS					
Q303	transistor, 2SC633A		All capacitance values are in μ F except as indicated with p, which means μ μ F.					
Q304	transistor, 2SC633A		C101	1-102-953	18p	$\pm 5\%$	50V	ceramic
Q305	transistor, 2SC633A		C102	1-102-953	18p	$\pm 5\%$	50V	ceramic
Q401	transistor, 2SC633A		C103	1-101-118	0.01	$\pm 20\%$	50V	ceramic
Q402	transistor, 2SC710		C104	1-101-923	0.01	$\pm 20\%$	25V	ceramic
Q403	transistor, 2SC710		C105	1-102-963	33p	$\pm 5\%$	50V	ceramic
Q404	transistor, 2SC710		C106	1-102-982	180p	$\pm 10\%$	50V	ceramic
			C107	1-101-924	0.02	$\pm 20\%$	25V	ceramic
			C108	1-101-924	0.02	$\pm 20\%$	25V	ceramic
			C109	1-101-924	0.02	$\pm 20\%$	25V	ceramic
			C110	1-101-118	0.01	$\pm 20\%$	50V	ceramic
			C111	1-102-806	27p	$\pm 5\%$	50V	ceramic

<u>Ref. No.</u>	<u>Part No.</u>	<u>Description</u>				<u>Ref. No.</u>	<u>Part No.</u>	<u>Description</u>			
C112	1-102-947	10p	±5%	50V	ceramic	C320	1-105-683-12	0.068	±10%	50V	mylar
C113	1-101-118	0.01	±20%	50V	ceramic	C321	1-105-665-12	0.0022	±10%	50V	mylar
C114						C322	1-105-665-12	0.0022	±10%	50V	mylar
C115						C323	1-105-665-12	0.0022	±10%	50V	mylar
C116	1-101-924	0.02	±80%	25V	ceramic	C324	1-105-665-12	0.0022	±10%	50V	mylar
C117	1-121-415	100	±100%	16V	electrolytic	C325	1-105-663-12	0.0015	±10%	50V	mylar
C118	1-102-862	3p	±0.25pF	50V	ceramic	C326	1-105-663-12	0.0015	±10%	50V	mylar
C119						C327	1-105-679-12	0.033	±10%	50V	mylar
C120	1-102-942	5p	±0.5pF	50V	ceramic	C328	1-105-679-12	0.033	±10%	50V	mylar
C121	1-102-942	5p	±0.5pF	50V	ceramic	C329	1-127-021	0.33	±20%	10V	solid, aluminum
C201	1-101-919	0.0022	±80%	25V	ceramic	C330	1-127-021	0.33	±20%	10V	solid, aluminum
C202	1-101-919	0.0022	±80%	25V	ceramic	C331	1-107-140	240p	±10%	50V	silvered mica
C203	1-101-919	0.0022	±80%	25V	ceramic	C401	1-101-924	0.02	±80%	25V	ceramic
C204	1-101-919	0.0022	±80%	25V	ceramic	C402	1-105-681-12	0.047	±10%	50V	mylar
C205						C403	1-101-924	0.02	±80%	25V	ceramic
C206						C404					
C207	1-102-977	200p	±5%	50V	ceramic	C405	1-101-924	0.02	±80%	25V	ceramic
C208	1-101-340	120p	±10%	50V	ceramic	C406	1-101-924	0.02	±80%	25V	ceramic
C209	1-101-340	120p	±10%	50V	ceramic	C407					
C210	1-121-402	33	±100%	10V	electrolytic	C408	1-103-608	200p	±5%	50V	styrol
C211	1-102-977	200p	±5%	50V	ceramic	C409					
C212	1-102-951	15p	±5%	50V	ceramic	C410	1-105-677-12	0.022	±10%	50V	mylar
C213	1-101-924	0.02	±80%	25V	ceramic	C411					
C214	1-121-402	33	±100%	10V	electrolytic	C412	1-101-924	0.02	±80%	25V	ceramic
C215	1-101-924	0.02	±80%	25V	ceramic	C413	1-101-884	56p	±5%	50V	ceramic
C216	1-121-398	10	±100%	25V	electrolytic	C414	1-101-924	0.02	±80%	25V	ceramic
C217	1-101-924	0.02	±80%	25V	ceramic	C415	1-105-679-12	0.033	±10%	50V	mylar
C218	1-101-924	0.02	±80%	25V	ceramic	C416	1-105-684-12	0.082	±10%	50V	mylar
C219	1-101-924	0.02	±80%	25V	ceramic	C417	1-121-409	47	±100%	16V	electrolytic
C220	1-121-403	33	±100%	16V	electrolytic	C418	1-101-924	0.02	±80%	25V	ceramic
C221	1-101-924	0.02	±80%	25V	ceramic	C419	1-105-669-12	0.0047	±10%	50V	mylar
C222	1-101-924	0.02	±80%	25V	ceramic	C420	1-101-924	0.02	±80%	25V	ceramic
C223	1-101-924	0.02	±80%	25V	ceramic	C421	1-101-924	0.02	±80%	25V	ceramic
C224	1-101-924	0.02	±80%	25V	ceramic	C422	1-121-391	1	±150%	50V	electrolytic
C225	1-101-924	0.02	±80%	25V	ceramic	C423	1-101-924	0.02	±80%	25V	ceramic
C226	1-101-924	0.02	±80%	25V	ceramic	C424	1-121-415	100	±100%	16V	electrolytic
C306	1-107-140	240p	±10%	50V	silvered mica	C425	1-121-392	3.3	±150%	25V	electrolytic
C307	1-121-398	10	±100%	25V	electrolytic	C426	1-121-392	3.3	±150%	25V	electrolytic
C308	1-121-415	100	±100%	16V	electrolytic	C427	1-127-019	0.1	±20%	10V	solid, aluminum
C309						C428	1-105-669-12	0.0047	±10%	50V	mylar
C310						C501 (C551)	1-121-391	1	±150%	50V	electrolytic
C311	1-102-977	200p	±5%	50V	ceramic	C502 (C552)	1-105-661-12	0.001	±10%	50V	mylar
C312	1-121-403	33	±100%	16V	electrolytic	C503 (C553)					
C313	1-102-977	200p	±5%	50V	ceramic	C504 (C554)	1-102-112	330p	±10%	50V	ceramic
C314	1-127-021	0.33	±20%	10V	solid, aluminum	C505 (C555)	1-121-391	1	±150%	50V	electrolytic
C315	1-105-683-12	0.068	±10%	50V	mylar	C506 (C556)	1-121-409	47	±100%	16V	electrolytic
C316	1-121-398	10	±100%	25V	electrolytic	C507 (C557)	1-105-667-12	0.0033	±10%	50V	mylar
C317	1-103-575	4,700p	±5%	50V	styrol	C508 (C558)	1-105-673-12	0.01	±10%	50V	mylar
C318	1-127-022	0.47	±20%	10V	solid, aluminum	C509 (C559)	1-105-673-12	0.01	±10%	50V	mylar
C319	1-105-683-12	0.068	±10%	50V	mylar						

<u>Ref. No.</u>	<u>Part No.</u>	<u>Description</u>			<u>Ref. No.</u>	<u>Part No.</u>	<u>Description</u>
C510 (C560)	1-102-816	120p	±5%	50V ceramic	R204	1-242-681	2.2 k
C511 (C561)	1-121-391	1	±150/10%	50V electrolytic	R205	1-244-657	220
C512 (C562)	1-121-391	1	±150/10%	50V electrolytic	R206	1-242-661	330
C513 (C563)	1-105-679-12	0.033	±10%	50V mylar	R207	1-244-677	1.5 k
C514 (C564)	1-105-665-12	0.0022	±10%	50V mylar	R208	1-244-679	1.8 k
C515 (C565)	1-105-679-12	0.033	±10%	50V mylar	R209	1-242-671	820
C516 (C566)	1-121-391	1	±150/10%	50V electrolytic	R210	1-244-673	1 k
C517 (C567)	1-121-391	1	±150/10%	50V electrolytic	R211	1-242-671	820
C518 (C568)	1-121-413	100	±100/10%	6.3V electrolytic	R212	1-242-705	22 k
C519 (C569)					R213	1-242-673	1 k
C520	1-121-398	10	±100/10%	25V electrolytic	R214	1-242-669	680
C521	1-121-413	100	±100/10%	6.3V electrolytic	R215	1-242-667	560
C601 (C651)	1-121-726	0.47	±150/10%	50V electrolytic	R216	1-244-675	1.2 k
C602	1-121-411	47	±100/10%	50V electrolytic	R217	1-242-689	4.7 k
C603 (C653)	1-121-411	47	±100/10%	50V electrolytic	R218	1-242-673	1 k
C604 (C654)	1-101-880	47p	±5%	50V ceramic	R219	1-244-673	1 k
C605 (C655)	1-101-880	47p	±5%	50V ceramic	R220	1-244-673	1 k
C606 (C656)	1-121-410	47	±100/10%	25V electrolytic	R221	1-244-647	82
C607 (C657)	1-105-679-12	0.033	±10%	50V mylar	R222	1-242-691	5.6 k
C608 (C658)	1-121-984	2,000	±100/10%	35V electrolytic	R223	1-242-691	5.6 k
C609	1-121-738	10	±100/10%	50V electrolytic	R224	1-244-657	220
C610 (C660)	1-121-738	10	±100/10%	50V electrolytic	R225	1-242-701	15 k
C611 (C661)	1-107-140	240p	±10%	50V silvered mica	R226	1-242-645	68
C801	1-121-410	47	±100/10%	25V electrolytic	R227	1-244-634	24
C802	1-121-422	220	±100/10%	25V electrolytic	R228	1-244-625	10
C803	1-121-361	470	±150/10%	35V electrolytic	R229	1-244-625	10
C804	1-121-422	220	±100/10%	25V electrolytic	R230		
C805	1-121-946	2,000	±50/10%	63V electrolytic	R231	1-244-689	4.7 k
C806	1-105-877-12	0.022	±20%	100V mylar	R232	1-244-637	33
C807	1-105-877-12	0.022	±20%	100V mylar	R233	1-242-697	10 k
C808	1-105-877-12	0.022	±20%	100V mylar	R234	1-244-680	2 k
C809	1-105-877-12	0.022	±20%	100V mylar	R235	1-242-645	68
					R236	1-242-667	560
					R237	1-242-705	22 k
					R238	1-242-673	1 k
					R308	1-242-703	18 k
					R309	1-242-697	10 k
					R310	1-242-717	68 k
					R311	1-242-713	47 k
					R312	1-242-689	4.7 k
					R313	1-244-673	1 k
					R314	1-242-697	10 k
					R315	1-244-721	100 k
					R316	1-244-649	100
					R317	1-242-689	4.7 k
					R318	1-244-715	56 k
					R319	1-244-661	330
					R320	1-242-669	680
					R321	1-244-690	5.1 k
					R322		
					R323	1-244-690	5.1 k
					R324	1-209-216	270 ±10% 1W
					R325	1-242-657	220

RESISTORS

All resistance values are in ohms, ±5%, ¼W and carbon type unless otherwise indicated.

R101	1-244-657	220
R102	1-244-701	15 k
R103	1-244-681	2.2 k
R104	1-242-665	470
R105	1-244-643	56
R106	1-244-643	56
R107	1-242-643	56
R108	1-242-673	1 k
R109	1-242-677	1.5 k
R110	1-244-693	6.8 k
R111	1-244-697	10 k
R112	1-244-657	220
R201	1-244-649	100
R202	1-242-671	820
R203	1-242-689	4.7 k

<u>Ref. No.</u>	<u>Part No.</u>	<u>Description</u>	<u>Ref. No.</u>	<u>Part No.</u>	<u>Description</u>
R326	1-244-666	510	R504 (R554)	1-244-687	3.9 k
R327	1-244-666	510	R505 (R555)	1-244-710	36 k
R328	1-242-673	1 k	R506 (R556)	1-244-723-09	120 k, noiseless
R329	1-242-673	1 k	R507 (R557)	1-244-661	330
R330	1-242-666	510	R508 (R558)	1-244-729-09	220 k, noiseless
R331	1-242-666	510	R509 (R559)	1-244-739-09	560 k, noiseless
R332	1-242-683	2.7 k	R510 (R560)	1-244-685-09	3.3 k, noiseless
R333	1-242-683	2.7 k	R511 (R561)	1-244-655	180
R334	1-242-672	910	R512 (R562)	1-244-695	8.2 k
R335	1-242-672	910	R513 (R563)	1-244-706	24 k
R336	1-242-686	3.6 k			
R337	1-242-686	3.6 k	R515 (R565)	1-244-689	4.7 k
R338	1-244-689	4.7 k	R516 (R566)	1-244-707	27 k
R339	1-244-689	4.7 k	R517 (R567)	1-244-687	3.9 k
R340	1-242-709	33 k	R518 (R568)	1-244-733-09	330 k, noiseless
R341	1-242-709	33 k	R519 (R569)	1-244-737-09	470 k, noiseless
			R520 (R570)	1-244-689-09	4.7 k, noiseless
R401	1-244-691	5.6 k	R521 (R571)	1-244-697	10 k
R402	1-242-664	430	R522 (R572)	1-244-697	10 k
R403	1-242-697	10 k	R523 (R573)	1-244-694	7.5 k
R404	1-242-693	6.8 k	R524 (R574)	1-244-697	10 k
R405	1-244-707	27 k	R525 (R575)	1-244-735-09	390 k, noiseless
R406	1-244-691	5.6 k	R526 (R576)	1-244-709-09	33 k, noiseless
R407	1-242-673	1 k	R527 (R577)	1-244-671	820
R408	1-244-673	1 k	R528 (R578)	1-244-685	3.3 k
R409	1-244-684	3 k	R529 (R579)	1-244-657	220
R410	1-244-671	820	R530 (R580)	1-244-689	4.7 k
R411	1-242-687	3.9 k	R531	1-244-719	82 k
R412	1-244-689	4.7 k	R540 (R590)	1-244-689	4.7 k
R413	1-244-665	470			
R414	1-244-643	56	R602	1-242-701	15 k
R415	1-244-689	4.7 k	R603	1-242-703	18 k
R416	1-244-645	68	R604 (R654)	1-242-721	100 k
R417	1-202-566	510	R605 (R655)	1-242-677	1.5 k
R418	1-244-691	5.6 k	R606 (R656)	1-242-673	1 k
R419	1-242-673	1 k	R607 (R657)	1-242-653	150
R420	1-244-679	1.8 k	R608 (R658)	1-244-693	6.8 k
R421	1-244-701	15 k	R609 (R659)	1-242-697	10 k
R422	1-244-719	82 k	R610 (R660)	1-242-684	3 k
R423	1-244-673	1 k	R611 (R661)	1-242-685	3.3 k
R424	1-244-671	820	R612 (R662)	1-242-661	330
R425	1-244-657	220	R613 (R663)	1-242-685	3.3 k
R426	1-244-669	680	R614 (R664)	1-242-665	470
R427	1-244-673	1 k	R615 (R665)	1-242-665	470
R428	1-242-689	4.7 k	R616 (R666)	1-242-605	1.5
R429	1-244-643	56	R617 (R667)	1-242-605	1.5
R430	1-242-632	20	R618 (R668)	1-242-625	10
R431	1-242-645	68	R619 (R669)	1-242-665	470
R432	1-244-655	180	R620 (R670)	1-202-565	470
R433	1-242-713	47 k	R621	1-244-685	3.3 k
			R622 (R672)	1-244-705	22 k
R501 (R551)	1-244-721	100 k			
R502 (R552)	1-244-713	47 k	R802	1-244-717	68 k
R503 (R553)	1-244-689	4.7 k	R803	1-244-683	2.7 k

±5% ½W composition

±10% ½W composition

<u>Ref. No.</u>	<u>Part No.</u>	<u>Description</u>	<u>Ref. No.</u>	<u>Part No.</u>	<u>Description</u>
R804	1-217-078	100 ±10% 5W wire-wound	CP901	1-231-057	encapsulated component, 120Ω + 0.033μF (USA Model only)
R805	1-244-699	12k	CP902	1-231-057	encapsulated component, 120Ω + 0.033μF
R806	1-206-044	680 ±10% 2W metal-oxide	J901, 951	1-507-251	jack, MICROPHONE
R807			J902	1-507-267	jack, HEADPHONE
R808	1-244-675	1.2k		1-507-268	phono jack, 8-P
R901 (R951)	1-244-719	82k	CNJ901	1-509-029	REC/PB connector
R902 (R952)	1-244-739	560k	CNJ902	1-509-403	ac outlet (USA Model only)
R903	1-244-633	22		1-509-445	ac input connector (AEP Model only)
R904	1-244-691	5.6k		1-517-050	socket, dial lamp
R905	1-202-645	1M ±10% ½W composition (USA Model only)	PL905	1-518-051	lamp, stereo 4.5V/40mA
RT501	1-221-320	3k (B), semi-fixed	PL902, 903	1-518-070	lamp, dial 8V/0.3A
RV501	1-222-543	250k (B), variable (VOLUME control)	PL904		
(RV551)			PL911	1-518-117	pointer with lamp
RV502	1-222-544	50k (B), variable (BASS control)	PL901	1-518-124	lamp, meter 8V/0.25A
(RV552)			M901	1-520-101	meter, TUNER INPUT
RV503	1-222-544	50k (B), variable (TREBLE control)	VS	1-526-165	voltage changeover block (AEP Model only)
(RV553)			F901	1-532-268 1-532-285	fuse, 2A (USA Model only)
RV504	1-222-545	20k (W), variable (BALANCE control)	F904, 905		1-532-078
SWITCHES			F906	1-532-204	fuse, 2A (AEP Model only)
S1	1-514-905	switch, rotary/slide (FUNCTION) (MONITOR)	F902, 903	1-532-298	fuse, 2A
S2	1-514-908	switch, push (MODE) (LOUDNESS)		1-533-048	fuse post
S3				1-533-051	holder, stereo lamp
S5				1-533-069	fuse holder, 4-P
S7	1-514-290	switch, push (SPEAKER)		1-534-526	cord, power (USA Model only)
S8	1-514-907	switch, slide (MODE)		1-536-179	terminal strip, 1L1
S901	1-514-505	switch, (POWER) . . . USA Model		1-536-187	terminal strip (USA Model only)
	1-514-911	switch, (POWER) . . . AEP Model		1-536-248	terminal post
FILTERS			TM902, 903	1-536-284	terminal strip, 4-P (SPEAKER)
CF201	1-527-507-11	fm i-f, ceramic 10.70 MHz (red)	TM901	1-536-286	terminal strip, 4-P (ANTENNA)
CF202	1-527-507-21	fm i-f, ceramic 10.66 MHz (black)		1-581-271	jumper board, 8-P phono jack
CF203	1-527-507-31	fm i-f, ceramic 10.74 MHz (white)			
CF204	1-527-507-41	fm i-f, ceramic 10.62 MHz (green)			
CF401	1-403-153	filter, ceramic 455 kHz			

SONY CORPORATION